



The Standard in Matters of Safety. PFISTERER.

When work is to be carried out on electrical installations, the safety of personnel, materials and system components must be given the highest priority. Although the safety measures and processes in different parts of the world are still not standardized, all operators are agreed on one point - safe working can only be ensured if a number of conditions are met:

- Regulations and instructions are followed meticulously and consistently
- Personnel have had solid training, and are continuously re-trained
- Mutual reliance when carrying out work on electrical installations
- Use of reliable tools and work equipment

In no Other Field of Application is the Quality of Tools and Work Equipment so Important.

It is here that, for decades, PFISTERER products have constantly been setting new standards. Our product range includes solutions that are tailored exactly to each specific requirement, and based on five safety rules recognised around the world:

- Isolate
- Reclosing lockout to prevent restarting
- Verify absence of voltage
- Earthing and short-circuiting measures
- Cover or safeguard any adjacent live parts



Backed up by decades of experience in developing safety equipment, and with our practical know-how, we know exactly how operators think and work. So no one knows all the requirements better than we do. Our highly-qualified staff applies this know-how in their development work, in the laboratory and in production. And the result is: uniquely reliable safety equipment.

Our core competence is in securing the absence of voltage and the earthing and short-circuiting of system components. Our product range includes:

- Capacitive voltage detectors for power systems above 1 kV AC.
- Double-pole voltage detectors for power systems between 500 V and 4,000 V DC
- Voltage detector types adapted to almost all existing railway systems
- Phase comparators and voltage-difference detecting devices for three-phase applications
- Voltage detecting systems for gas-insulated load switching equipment and switchgear
- Earthing and short-circuiting devices in all useful types and variations for high short-circuit loads
- Earth clamps, line clamps and connection elements for all common applications
- Insulating poles as earthing or operating poles

Every PFISTERER safety product is matched exactly to the corresponding customer requirement. Special IT-assisted logistics processes have been developed for the earthing and short-circuiting devices. This means short delivery times, even for special variants.

This product catalogue shows a representative selection of the most popular items in our product range.

We can supply additional types and add-ons on request.

Voltage Detectors	Page 10 - 31	I
Phase Comparators	Page 32 - 35	II
Operating Poles	Page 36 - 41	III
Earthing Poles	Page 42 - 47	IV
Earthing and Short-circuiting Devices	Page 48 - 81	V
Voltage Detecting Systems	Page 82 - 88	VI
Accessories	Page 89 - 99	VII

Voltage Detectors

Phase Comparators

Operating Poles

Earthing Poles



Voltage Detectors for Medium Voltage
Page 11 – 14



Voltage Detectors for High Voltage
Page 15 – 16



Voltage Detectors for Railway Systems
Page 17 – 24



Insulating Poles for Voltage Detectors
Page 25 – 30

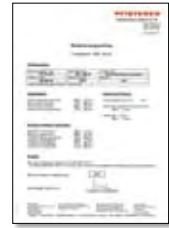

In-service tests for voltage detectors
Page 31



Single-pole Phase Comparators
Page 32 – 33



Deltameter 5
Page 34

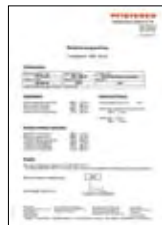

In-service Tests for Phase Comparators
Page 35



Insulating Poles
Page 36 – 37



Switching Poles
Page 38



Insulating Working Poles
Page 39 – 40



Fuse Tong
Page 41



Earthing Poles
Page 42 – 45



Earthing Poles for Railway Systems
Page 46 – 47

Earthing and Short-circuiting Devices

Voltage Detecting Systems

Accessories



Earthing and Short-circuiting Devices
Page 48 – 57



Special Earthing Fittings
Page 58



Earthing and Short-circuiting Devices for Railway Systems
Page 59 – 61



Earth Clamps
Page 62 – 69



Rail Earth Clamps
Page 70



Line Clamps
Page 71 – 74



Contact Wire Earth Clamps
Page 75 – 76



Earthing and Phase Fixed Points
Page 77 – 81



Indicators
Page 82 – 84



Interfaces and Connecting Leads
Page 85



Testers
Page 86 – 88



In-service Tests for EPV Phase Comparators
Page 88



Accessories
Page 89 – 97



Spare Parts
Page 98 – 99



Voltage Detectors

One of the most important operations when working on electrical switchgear is to check that voltage is absent, and this requires voltage detectors that meet the highest quality and reliability requirements. PFISTERER voltage detectors meet these requirements without exception.

The **KP-Test 5** Series voltage detectors provide an exceptional combination of user comfort and safety in one device. The optimum LED layout, integrated audible signals and innovative self-test features form the basic elements on all equipment types. Thanks to our long years of experience, we are able to develop and supply voltage detectors that work reliably even in critical situations in the field.

KP-Test 5 Series voltage detectors can be supplied as capacitive single-pole voltage detectors for a.c. voltages from 1 to 420 kV, or resistive double pole voltage detectors from 500 to 4,000 V, in various types.

Equipment types:

The possible operating conditions should be taken into consideration when selecting a suitable voltage detector. Voltage detectors with a contact electrode extension have universal application, as they allow reliable indications even in difficult electrical field conditions.

KP-Test 5:

- For medium voltage applications with contact electrode extension
- Nominal voltages from 1 to 36 kV, Type S

KP-Test 5 dual:

- For medium voltage applications with contact electrode extension and nominal voltage range selector
- Nominal voltages from 3 to 36 kV, Type S

KP-Test 5L:

- Mainly for use on medium voltage overhead lines
- Nominal voltages from 3 to 36 kV, Type L

KP-Test 5L dual:

- Mainly for use on medium voltage overhead lines with nominal voltage range selector
- Nominal voltages from 3 to 36 kV, Type L

KP-Test 5H:

- For high voltage applications with contact electrode extension
- Nominal voltages from 30 to 420 kV, Type S

KP-Test 5HL:

- For use on high voltage overhead lines
- Nominal voltages from 30 to 420 kV, Type L

KP-Test 5R DC:

- For use on the catenary systems of d.c. voltage railways
- Nominal voltages from 500 to 4,000 V d.c.

KP-Test 5R DC dual:

- For use on the catenary systems of d.c. voltage railways, with nominal voltage range selector
- Nominal voltages from 500 to 4,000 V d.c.

KP-Test 5 DC:

- For use on the catenary systems of d.c. voltage systems and railways with a third rail
- Nominal voltages from 500 to 4,000 V d.c.

KP-Test II:

- For use on the catenary systems of a.c. voltage railways
- Nominal voltages 15 kV 16.7 Hz and 25 kV 50 Hz

Voltage Detectors KP-Test 5

The **KP-Test 5** capacitive voltage detector can be used for indoor and outdoor medium voltage applications. It indicates the presence of operating voltage when the conductor is contacted. The **KP-Test 5** voltage detector is distinguished by its high level of user-friendliness and user safety.

Technical description:

- Integrated audible signal for reliable voltage tests, even in noisy ambient conditions
- Can be used during precipitation
- Extremely bright LEDs in clear layout to prevent confusion
- Maximum interference field protection through use of a high-quality contact electrode extension
- Extensive self-test at switch-on, which even checks the contact electrode extension
- Removable contact electrode top piece included as forked electrode
- Rated frequency 50 Hz
- Length of insulating element when assembled 520 mm
- Diameter of insulating element when assembled 24 mm

The **KP-Test 5** is designed and type-tested to Standard IEC 61243-1:2003.

Other types with different nominal voltages, nominal voltage ranges and frequencies are available on request.

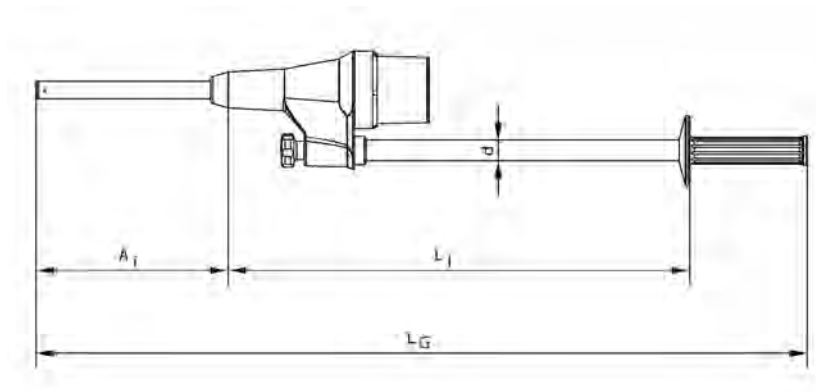

No.	Nominal voltage	Total length	Insertion depth	Length of handle
	U_n (kV)	L_G (mm)	A_i (mm)	L_H (mm)
930 100 003	3	887	220	135
930 100 005	5	887	220	135
930 100 010	10	887	220	135
930 110 005	5 - 6	1060	393	135
930 110 010	10 - 12	1060	393	135
930 110 013	13	1060	393	135
930 110 020	20	1060	393	135
930 120 003	3 - 10	1270	603	135
930 120 005	5 - 10	1270	603	135
930 120 010	10 - 20	1270	603	135
930 140 010	10 - 30	1730	910	288
930 140 020	20 - 36	1730	910	288



Voltage Detectors KP-Test 5 dual

The **KP-Test 5 dual** capacitive voltage detector is similar in design to the **KP-Test 5**. This voltage detector can also be switched between two nominal voltage ranges. This allows a larger system range to be covered with the same interference field resistance.

Technical description:

- Integrated audible signal for reliable voltage tests even in noisy ambient conditions
- Can be used during precipitation
- Extremely strong LEDs in clear layout to prevent confusion
- Maximum interference field resistance through the use of a high-quality contact electrode extension
- Extensive self-test functions at switch-on, which even check the contact electrode extension
- Removable contact electrode headpiece included as forked electrode
- Switching between two voltage ranges by means of a switch
- 50 Hz rated frequency

The **KP-Test 5 dual** meets Standard IEC 61243-1:2003.

Other types with different nominal voltages and ranges of nominal voltages and frequencies are available on request.

No.	Version	Nominal voltage level I	Nominal voltage level II	Total length	Insertion depth
		U_n (kV)	U_n (kV)		
930 190 501	0008	3	10 - 13	1060	393
930 190 501	0005	5 - 12	20 - 36	1730	910

Voltage Detectors KP-Test 5L

The **KP-Test 5L** capacitive voltage detector is intended mainly for use on medium voltage overhead lines. It indicates the presence of operating voltage when the conductor is contacted. The **KP-Test 5L** voltage detector is distinguished by its compact design and maximum user safety.

Technical description:

- Class L as defined in IEC 61243-1
- Can be used during precipitation
- Integrated audible signal for reliable voltage tests even in noisy ambient conditions
- Extremely strong LEDs in clear layout to prevent confusion
- Extensive self-test functions at switch-on
- Available separately for use with existing insulating poles
- Available complete with suitable insulating poles in any overall length or carrying length
- Nominal frequency 50 Hz
- Overall device length without insulating poles 345 mm

The **KP-Test 5L** is designed and type-tested to Standard IEC 61243-1:2003.

Suitable insulating poles:

- 973 501 001 with $L_o = 725$ mm
- 624 760 001 with $L_o = 1485$ mm

Other types with different nominal voltages, ranges of nominal voltages and frequencies are available on request.

No.	Version	Nominal voltage
		U_n (kV)
930 210 001	0005	11 - 33
930 210 001	0006	12 - 24





Voltage Detectors KP-Test 5L dual

The **KP-Test 5L dual** capacitive voltage detector is similar in design to the **KP-Test 5L**. This voltage detector can also be switched between two nominal voltage ranges. This allows a larger system range to be covered with the same interference field resistance.

Technical description:

- Class L as defined in IEC 61243-1
- Can be used during precipitation
- Switching between two voltage ranges using a switch
- Integrated audible signal for reliable voltage tests even in noisy ambient conditions
- Extremely strong LEDs in clear layout to prevent confusion
- Extensive self-test functions at switch-on
- Available separately for use with existing insulating poles
- Available complete with suitable insulating poles in any overall length or carrying length
- Nominal frequency 50 Hz
- Overall device length without insulating poles 345 mm

The **KP-Test 5L dual** meets Standard IEC 61243-1:2003.

Suitable insulating poles:

- 973 501 001 with $L_o = 725$ mm
- 624 760 001 with $L_o = 1485$ mm

Other types with different nominal voltages, ranges of nominal voltages and frequencies are available on request.

No.	Version	Nominal voltage	Nominal voltage
		level I	level II
		U_n (kV)	U_n (kV)
930 210 501	0005	3 - 10	11 - 36

Voltage Detectors KP-Test 5H

The **KP-Test 5H** capacitive voltage detector has universal high voltage application for nominal voltages from 30 to 420 kV. It indicates the presence of operating voltage when the conductor is contacted. The **KP-Test 5H** voltage detector is distinguished by its high level of user-friendliness and user safety.

Technical description:

- Available for different ranges of nominal voltages from 30 to 420 kV
- Can be used during precipitation
- Particularly loud, integrated audible signal for reliable voltage tests even in noisy ambient conditions
- Extremely strong LEDs in clear layout to prevent confusion
- Maximum interference field resistance through the use of a high-quality contact electrode extension
- Extensive self-test functions at switch-on
- Available separately for use with existing insulating poles
- Available complete with suitable insulating poles in any overall length or carrying length
- Insertion depth $A_I = 898$ mm



The **KP-Test 5H** is constructed and type-tested to Standard IEC 61243-1:2003.

The KP-Test 5H Series voltage detector is also available with a carrying case on request.

Other types with different nominal voltages, ranges of nominal voltages and frequencies are available on request.

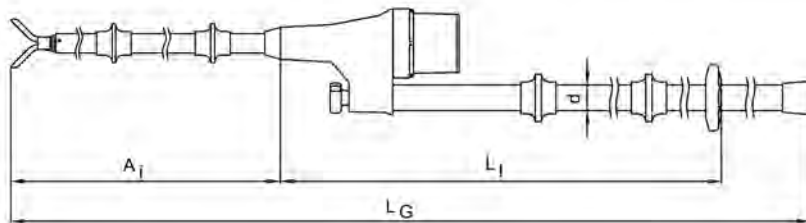

No.	Version	Nominal voltage	Insulating length	Total length	Transporting length	Number of insulating poles
		U_n (kV)	L_I (mm)	L_G (mm)	L_T (mm)	
930 250 001	0028	30 - 60 kV / 50 Hz	975	2478	1485	1
930 250 001	0003	50 - 110 kV / 50 Hz	1802	3700	1855	2
930 250 001	0089	60 - 110 kV / 50 Hz	2875	4773	2050	2
930 250 001	0115	110 kV / 50 Hz	1802	3700	1855	2
930 250 001	0002	110 - 220 kV / 50 Hz	3220	5118	2050	3
930 250 001	0023	220 - 380 kV / 50 Hz	3850	5748	2050	3
930 250 001	0024	220 - 420 kV / 50 Hz	3850	5748	2050	3
930 250 001	0026	400 kV / 50 Hz	3850	5748	2050	3



Voltage Detectors KP-Test 5HL

The **KP-Test 5HL** capacitive voltage detector can be used on high-voltage overhead lines with nominal voltages from 30 to 420 kV. It indicates the presence of operating voltage when the conductor is contacted. The **KP-Test 5HL** voltage detector provides particularly easy handling, while ensuring maximum user safety.

Technical description:

- Class L as defined in IEC 61243-1
- Available for various ranges of nominal voltages from 30 to 420 kV
- Can be used during precipitation
- Particularly loud, integrated audible signal for reliable voltage tests even in noisy ambient conditions
- Extremely strong LEDs in clear layout to prevent confusion
- Extensive self-test functions at switch-on
- Connection for insulating poles with universal adapter
- Eye ring for attaching the voltage detector, for example to a spring safety hook
- Available separately for use with existing insulating poles
- Available complete with suitable insulating poles in any overall length or carrying length

The **KP-Test 5HL** is constructed and type-tested to Standard IEC 61243-1:2003.

Suitable adapter:

- C2B, 935 101 002
- C2C, 935 101 003
- C2D, 935 101 004
- C2F, 935 101 005

Other types with different nominal voltages, ranges of nominal voltages and frequencies are available on request.

No.	Version	Nominal voltage	Nominal frequency	Diameter of hook electrode
		U_n (kV)	f_N (Hz)	d (mm)
930 200 001	0010	30 - 60	50	20
930 200 002	0010	110 - 220	50	70
930 200 002	0011	220 - 420	50	70

Voltage Detectors for Railway Systems

The electric railway systems around the world are operated with different voltage systems. PFISTERER can supply voltage detectors for all common voltage systems.

- 15 kV at 16.7 Hz
- 25 kV at 50 Hz
- 1,500 V d.c.
- 3,000 V d.c.
- Voltage supply for trolley lines
- Voltage supply for urban track systems with third rail

Depending on type, our voltage detectors are suitable for use on railway catenaries and power lines, and also on switchgears.

Voltage Detectors KP-Test 5R DC

The **KP-Test 5R DC** double-pole voltage detector is designed for use on the catenary systems of d.c. voltage railways. It indicates the presence of operating voltage when the conductor is contacted. With its extensive, integrated self-tests, the **KP-Test 5R DC** voltage detector ensures maximum user safety.

Technical description:

- Double-pole type for the catenary systems of d.c. voltage railways with nominal voltages from 500 to 4,000 V DC
- Second pole designed for handy magnetic connection to rail
- Hook-type contact electrode with high-quality contact pin for optimum contact
- Self-test at switch-on also checks the connecting cable
- Can be used during precipitation
- Integrated audible signal for reliable voltage tests even in noisy ambient conditions
- Extremely strong LEDs in clear layout to prevent confusion
- Induced a.c. voltage signal detection
- Voltage testing possible even with a high proportion of leakage current on disconnected contact wires
- Available separately without insulating pole
- Available separately without insulating pole, but with additional adapter
- Available complete with three-piece insulating pole (poles **RP1** and **UP**; total length about 5,000 mm), or five-piece insulating pole (poles **RP2**, **RP3**, **RP4** and **UP**; total length about 4,880 mm)
- Available with convenient carrying case

Other types with different nominal voltages and ranges of nominal voltages are available on request.

No.	Version	Nominal Voltage DC U_n (V)
930 350 001	0022	650 - 750
930 350 001	0023	750
930 350 001	0024	1,500
930 350 001	0025	3,000





Voltage Detectors KP-Test 5R DC dual

The **KP-Test 5R DC dual** double-pole voltage detector is similar in design to the **KP-Test 5R DC**. This voltage detector can also be switched between two nominal voltage ranges in two steps. This allows a larger system range to be covered even when there is a high proportion of leakage current.

The KP-Test 5R DC dual has two selectable voltage steps.

Step 1:

- Voltage 750 V DC
- Selected by briefly pressing the On button
- LED indicator: 1 x green

Step 2:

- Voltage 1,500 V DC
- Selected by pressing and holding the On button
- LED indicator: 2 x green

Sensible voltage level selection at switch-on and the related self-test ensure that the **KP-Test 5R DC dual** displays safe, clear indications.

Technical description:

- Double-pole type for the catenary systems of d.c. voltage railways with nominal voltages from 500 to 4,000 V DC
- Second pole designed for handy magnetic connection to rail
- Voltage range selection
- Hook-type contact electrode with high-quality contact pin for optimum contact
- Self-test at switch-on also checks the connecting cable
- Can be used during precipitation
- Integrated audible signal for reliable voltage tests even in noisy ambient conditions
- Extremely strong LEDs in clear layout to prevent confusion
- Induced a.c. voltage signal detection
- Voltage testing possible even with a high proportion of leakage current on disconnected contact wires
- Available separately without insulating pole
- Available separately without insulating pole, but with additional adapter
- Available complete with three-piece insulating pole (poles **RP1** and **UP**; total length about 5,000 mm), or five-piece insulating pole (poles **RP2**, **RP3**, **RP4** and **UP**; total length about 4,880 mm)
- Available with convenient carrying case

Other types with different nominal voltages and ranges of nominal voltages are available on request.

No.	Version	Nominal voltage DC	Nominal voltage DC
		Level I	Level II
		U_n (V)	U_n (V)
930 350 501	0005	750	1,500

Voltage Detectors KP-Test 5H for Railway Systems

The **KP-Test 5 H for railway** capacitive voltage detector is similar in design to the **KP-Test 5 H**. This voltage detector is designed specially for application on supply line for railway systems. It indicates the presence of operating voltage when the conductor is contacted. The **KP-Test 5H for railway** voltage detector is distinguished by its high level of user-friendliness and user safety.

Technical description:

- Can be used during precipitation
- Particularly loud, integrated audible signal for reliable voltage tests even in noisy ambient conditions
- Extremely strong LEDs in clear layout to prevent confusion
- Maximum interference field resistance through the use of a high-quality contact electrode extension
- Extensive self-test functions at switch-on
- Available with convenient carrying case

The **KP-Test 5H for railway** is constructed and type-tested to Standard IEC 61243-1:2003.

Other types with different nominal voltages, ranges of nominal voltages and frequencies are available on request.

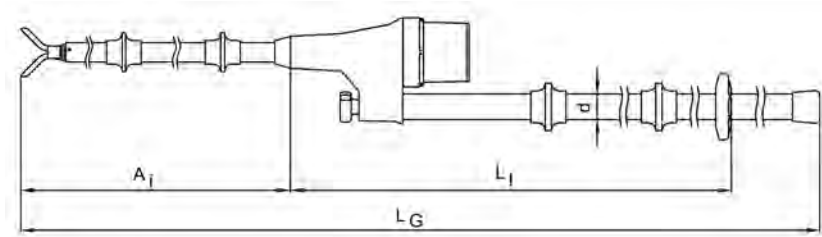

No.	Version	Nominal voltage	Insulating length	Total length	Transporting length	Number of insulating poles
		U_n (kV)	L_I (mm)	L_G (mm)	L_T (mm)	
930 250 001	0128	110 kV / 16,7 & 50 Hz	1802	3700	1855	2
930 250 001	0032	132 kV / 16,7 & 50 Hz	1802	3700	1855	2





Voltage Detectors KP-Test 5 for Railway Power Lines

The **KP-Test 5 capacitive voltage detector for railway power lines** can be used on 15 kV 16.7 Hz railway power lines. It indicates the presence of operating voltage when the conductor is contacted. This voltage detector is suitable for the particular requirements of railway power lines.

Technical description:

- Integrated audible signal for reliable voltage tests even in noisy ambient conditions
- Can be used during precipitation
- Extremely strong LEDs in clear layout to prevent confusion
- Maximum interference field resistance through the use of a high-quality contact electrode extension
- Extensive self-test functions at switch-on, which even check the contact electrode extension
- Removable contact electrode headpiece as hook electrode
- Handle length 288 mm
- Length of insulating element 520 mm

No.	Version	Nominal voltage	Nominal frequency	Total length	Insertion depth
		U_n (kV)	f_N (Hz)	L_G (mm)	A_i (mm)
930 190 001	0025	15	16.7	1810	910

Voltage Detectors KP-Test 5 for Railway Substation

The **KP-Test 5 capacitive voltage detector for railway substation** can be used on 15 kV 16.7 Hz. It indicates the presence of operating voltage when the conductor is contacted. The **KP-Test 5 capacitive voltage detector for railway substation** voltage detector is distinguished by its high level of user-friendliness and user safety.

Technical description:

- Can be used during precipitation
- Particularly loud, integrated audible signal for reliable voltage tests even in noisy ambient conditions
- Extremely strong LEDs in clear layout to prevent confusion
- Maximum interference field resistance through the use of a high-quality contact electrode extension
- Extensive self-test functions at switch-on, which even check the contact electrode extension

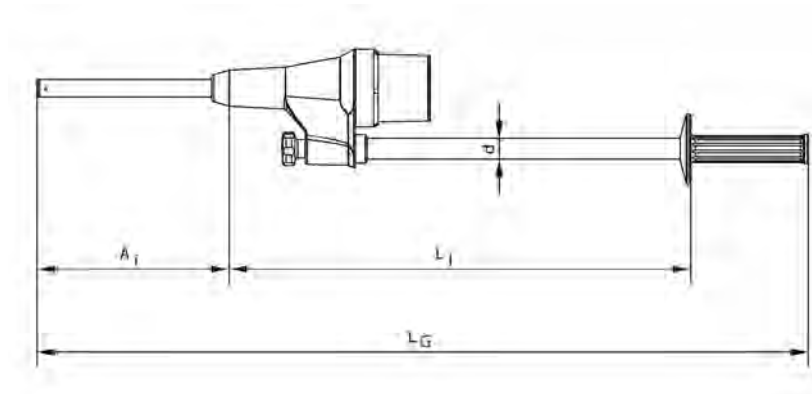

No.	Version	Total length	Insertion depth	Length of insulating element	Length of handle
		L_G (mm)	A_I (mm)	L_I (mm)	L_H (mm)
930 190 001	0122	1270	603	520	135



Voltage Detectors KP-Test II, 15 kV 16.7 Hz, five-piece

The **KP-Test II capacitive voltage detector for 15 kV 16.7 Hz catenaries** can be used on 15 kV 16.7 Hz railway overhead lines. It indicates the presence of operating voltage when the conductor is contacted. The voltage detector can be disassembled into five separate components for optimum transport in emergency vehicles.

The voltage detector is supplied with a convenient carrying case.

Technical description:

- External audible signal for reliable voltage tests even in noisy ambient conditions
- Can be used during precipitation
- Hook-type contact electrode with high-quality contact pin for optimum contact
- Extensive self-test functions at switch-on

The KP-Test II for 15 kV 16.7 Hz catenaries is designed to meet Standard DIN VDE 0681, Part 6.

No.	Nominal voltage U_n (kV)	Nominal frequency f_N (Hz)	DB no.	DB drawing number	SBB no.
364 456 002	15	16.7	00662384	3 Ebgw 02.13	-
364 456 005	15	16.7	-	-	386.04.57

Voltage Detectors KP-Test II, 15 kV 16.7 Hz, two-piece

The **KP-Test II capacitive voltage detector for 15 kV 16.7 Hz catenaries** can be used on 15 kV 16.7 Hz railway overhead lines. It indicates the presence of operating voltage when the conductor is contacted.

The voltage detector is supplied with a convenient carrying case.

Technical description:

- External audible signal for reliable voltage tests even in noisy ambient conditions
- Can be used during precipitation
- Hook-type contact electrode with high-quality contact pin for optimum contact
- Extensive self-test functions at switch-on

The KP-Test II for 15 kV 16.7 Hz catenaries is designed to meet Standard DIN VDE 0681, Part 6.



No.	Nominal voltage U_n (kV)	Nominal frequency f_N (Hz)	DB no.	DB drawing number	SBB no.
363 625 001	15	16.7	00237127	3 Ebgw 02.11	-
363 625 004	17,5	16.7	-	-	-
363 625 005	15	16.7	-	-	386.04.56

Voltage Detectors KP-Test II, 25 kV 50 Hz, five-piece

The **KP-Test II capacitive voltage detector for 25 kV 50 Hz catenaries** can be used on 25 kV 50 Hz railway overhead lines. It indicates the presence of operating voltage when the conductor is contacted. The voltage detector can be disassembled into five separate components for optimum transport in emergency vehicles.

The voltage detector is supplied with a convenient carrying case.

Technical description:

- External audible signal for reliable voltage tests even in noisy ambient conditions
- Can be used during precipitation
- Hook-type contact electrode with high-quality contact pin for optimum contact
- Extensive self-test functions at switch-on
- For single-phase systems

The voltage detector is similar in design to type 364 456 002.



No.	Nominal voltage	Nominal frequency
	U_n (kV)	f_N (Hz)
364 456 003	25	50

Voltage Detectors KP-Test II, 25 kV 50 Hz, two-piece

The **KP-Test II capacitive voltage detector for 25 kV 50 Hz catenaries** can be used on 25 kV 50 Hz railway overhead lines. It indicates the presence of operating voltage when the conductor is contacted.

The voltage detector is supplied with a convenient carrying case.

Technical description:

- External audible signal for reliable voltage tests even in noisy ambient conditions
- Can be used during precipitation
- Hook-type contact electrode with high-quality contact pin for optimum contact
- Extensive self-test functions at switch-on
- For single-phase systems

The voltage detector is similar in design to type 363 625 001.

No.	Nominal voltage	Nominal frequency
	U_n (kV)	f_N (Hz)
364 454 004	25	50





Voltage Detectors KP-Test 5 DC

The **KP-Test 5 DC** double-pole voltage detector is suitable for use on the switchgear of d.c. voltage railways and railway systems with a third rail. It indicates the presence of operating voltage when the conductor is contacted. With its extensive, integrated self-tests, the **KP-Test 5 DC** voltage detector ensures maximum user safety. It also provides maximum operating comfort.

Technical description:

- Double-pole type for use on the switchgear of d.c. railways with a third rail and nominal voltages from 500 to 4,000 V d.c.
- Self-test at switch-on also checks the connecting cable
- Can be used when there is precipitation
- Integrated audible signal for reliable voltage tests even in noisy ambient conditions
- Extremely strong LEDs in clear layout to prevent confusion
- Induced a.c. voltage signals detected

Other types with different nominal voltages and ranges of nominal voltages and frequencies are available on request.

No.	Total length
	L_c (mm)
930 370 001	815

Insulating Poles for Voltage Detectors

These insulating poles can be used with all KP-Test 5 Series voltage detectors. This allows voltage detectors to be optimized for particular applications on the system.

Technical description:

- Yellow varnished FRP tubes with optimal leakage values
- Hexagon connection for KP-Test 5 Series voltage detectors

Insulating Poles for Voltage Detectors, Type IP

One-piece insulating pole with end cap, hand guard and hexagon connection for KP-Test 5 Series voltage detectors

No.	Total length	Insulating length	Length of handle	Diameter of insulating element
	L_G (mm)	$L_{i IP}$ (mm)	L_H (mm)	d (mm)
973 500 001	572	-	135	24
973 501 001	725	-	285	24
624 760 001	1485	830	605	33

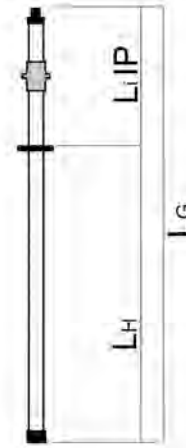

Insulating Pole Base Parts for Voltage Detectors, Type BP

Insulating pole base part with end cap, hand guard and plug-in connection for insulating pole upper or intermediate parts, for multi-piece insulating poles.

No.	Total length	Insulating length	Length of handle	Diameter of insulating element
	L_G (mm)	$L_{i BP}$ (mm)	L_H (mm)	d (mm)
624 333 502	1225	225	1000	43
624 333 504	1500	500	1000	43
624 334 501	1855	855	1000	43
624 334 502	2010	1010	1000	43

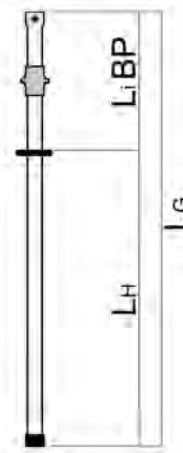

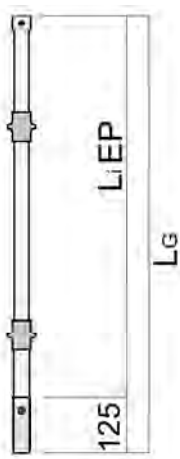
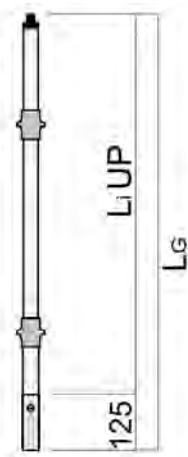

Insulating Pole Upper Parts for Voltage Detectors, Type UP

Insulating pole upper part for multi-piece insulating poles. With hexagon connection for KP-Test 5 Series voltage detectors.

No.	Total length	Insulating length	Diameter of insulating element
	L _g (mm)	L _i UP (mm)	d (mm)
624 780 002	977	802	33
624 780 001	2050	1875	33

Insulating Pole Intermediate Parts for Voltage Detectors, Type EP

Insulating pole intermediate part for multi-piece insulating poles. Plugs in between insulating pole upper part and base part.

No.	Total length	Insulating length	Diameter of insulating element
	L _g (mm)	L _i EP (mm)	d (mm)
624 336 501	1100	975	43
624 336 002	3130	3005	43

Insulating Pole Extensions for Voltage Detectors

This insulating pole extension makes it simple to extend the PFISTERER insulating poles of voltage detectors. The insulating pole extension is screwed onto the existing insulating pole. This does not reduce the minimum insulation length.

These insulation pole extensions can be used for:

- KP-Test 5
- KP-Test 5 dual
- KP-Test 5L
- KP-Test 5L dual

No.	Total length	Diameter of insulating element
	L _g (mm)	d (mm)
620 518 002	560	24
620 518 001	1060	24

Insulating Poles for Voltage Detectors KP-Test 5 and 5H

Minimum length of insulating elements L_i by standard EN 61243-1

U_r (kV)	L_i (mm)
$1 < U_r \leq 36$	520
$36 < U_r \leq 72,5$	830
$72,5 < U_r \leq 123$	1300
$123 < U_r \leq 170$	1700
$170 < U_r \leq 245$	2300
$245 < U_r \leq 420$	3600

U_r = rating voltage

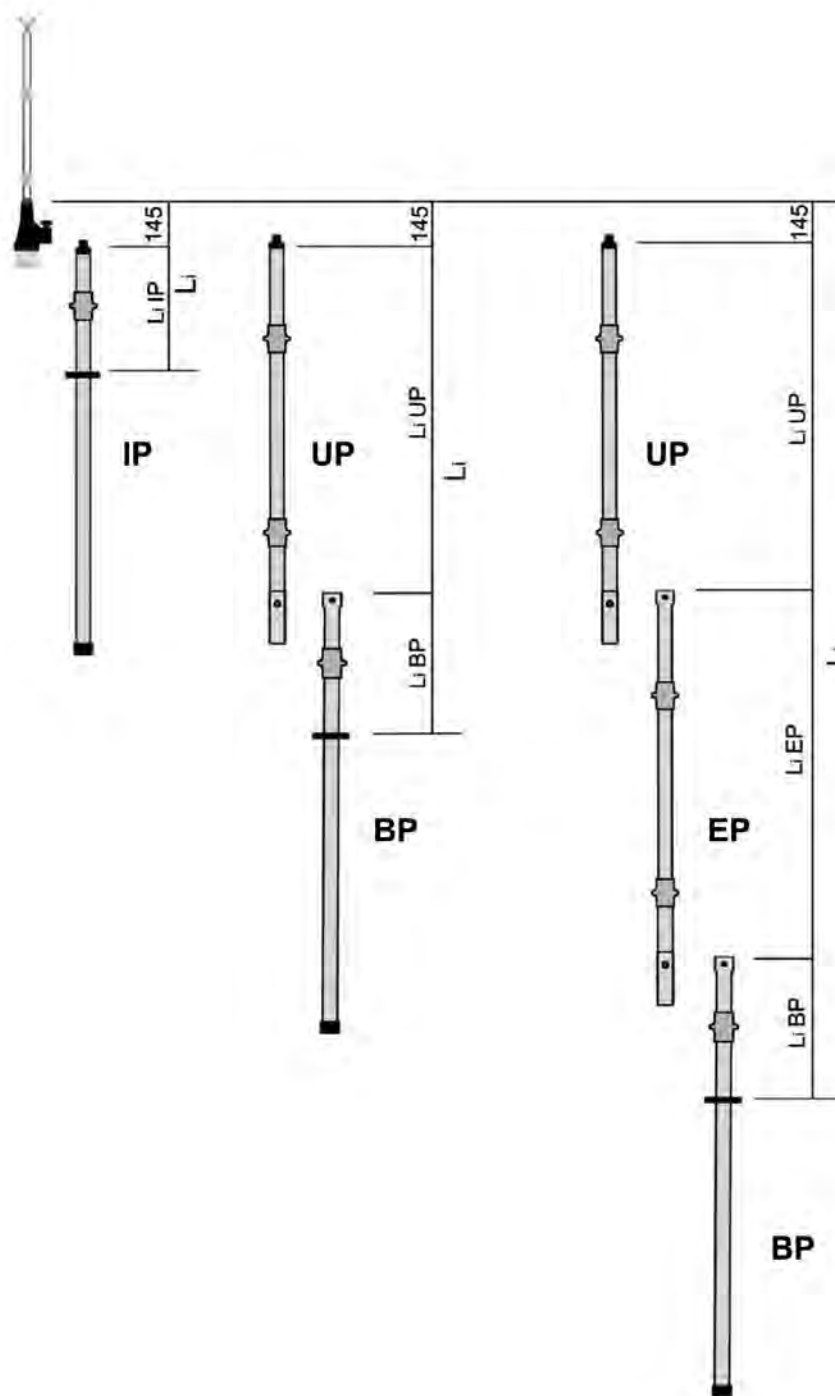



Insulating Poles for Railway Voltage Detectors

This insulating poles are applicable to all KP-Test 5R voltage detectors series. Optimal way for laying out voltage detectors for respective applications.

Technical description:

- Hexagon connection for KP-Test 5 Series voltage detectors
- Yellow, respectively white varnished FRP tubes with optimal leakage values

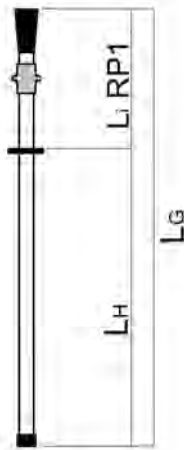

Insulating Pole Base Parts for Three-part Voltage Detectors, Type RP1

Insulating pole base part with end cap, hand guard and plug-in connection for insulating pole upper parts UP.

No.	Total length	Insulating length	Length of handle	Diameter of insulating element
	L _g (mm)	L _i RP1 (mm)	L _h (mm)	d (mm)
620 780 002	1950	480	1465	33
620 780 001	2450	480	1965	33

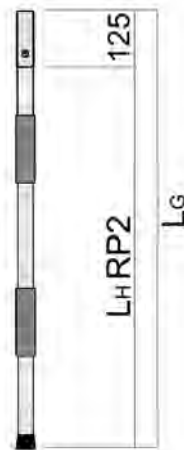

Insulating Pole Base Parts for Five-part Voltage Detectors, Type RP2

Insulating pole base part with end cap, hand guard and plug-in connection for insulating pole intermediate parts RP3.

No.	Total length	Length of handle	Diameter of insulating element
	L _g (mm)	L _h RP2 (mm)	d (mm)
623 930 001	1080	955	43

Insulating Pole Intermediate Parts for Five-part Voltage Detectors, Type RP3

Insulating intermediate part with plug-in connection for insulating pole intermediate parts RP4.

No.	Total length	Length of handle	Diameter of insulating element
	L _G (mm)	L _H RP3 (mm)	d (mm)
623 929 001	1080	955	43

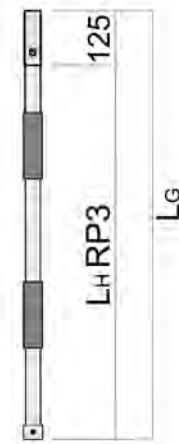

Insulating Pole Intermediate Parts for Five-part Voltage Detectors, Type RP4

Insulating base part with plug-in connection for insulating pole upper parts UP.

No.	Total length	Insulating length	Length of handle	Diameter of insulating element
	L _G (mm)	L _I RP4 (mm)	L _H RP4 (mm)	d (mm)
623 929 100	1010	65	945	43

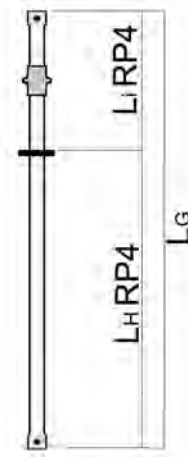

Insulating Poles for Voltage Detectors KP-Test 5R DC and KP-Test 5R DC dual

Minimum length of insulating elements L_i

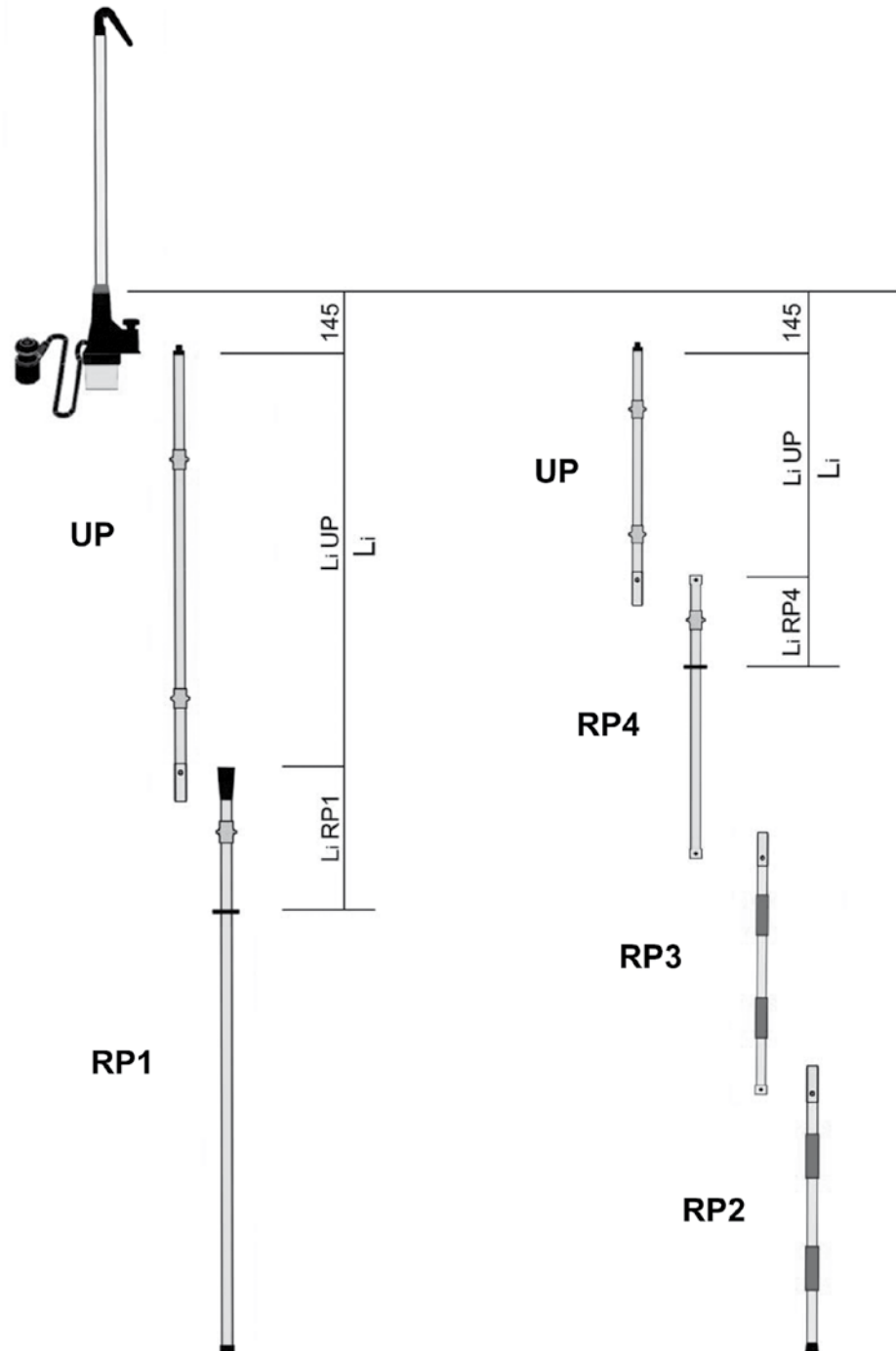



In-service Tests for Voltage Detectors

Depending on national regulations in the country concerned, in-service tests are required for voltage detectors with nominal voltages above 1 kV. In Germany, these are obligatory under the „Electrical installations and equipment“ (BGV A3) accident prevention rule. Voltage detectors must then, within a maximum period of six years, be submitted to another in-service test and specified checks. The appendix of Standard IEC 61243-1 gives a description of these tests.

PFISTERER have been successfully carrying out these in-service tests on their own test equipment for many years. The voltage detectors are tested according to the specifications, and immediately adjusted if necessary. Whenever extensive repairs are necessary, we give a cost quotation.

When the tests are completed, the results are documented in detail.

To request an In-service test, please contact your local sales agency.

For customers in Germany please use the following mailing address:

PFISTERER Kontaktsysteme GmbH & Co. KG
 Bereich Wiederholungsprüfung
 Bahnhofstraße 30
 89547 Gerstetten - Gussenstadt
 Germany



In-service Tests for Voltage Detectors

No.	Description
200 000 001	KP-Test II
200 000 002	KP-Test III
200 000 003	KP-GLI
200 000 004	KP-Test II Railway
200 000 005	KP-Test II USE
200 000 006	Testing set
200 000 014	SONIC signal application
200 000 200	KP-Test 5

Single-pole Phase Comparators

Phase comparators for medium voltage are used to check phase coincidence in three-phase networks. Single-pole phase comparators of type SPPC have the same construction as PFISTERER voltage detectors. This ensures a high level of both safety and reliability.

Phase comparison takes place using a single-pole phase comparator SPPC, and making contact with both conductors one after the other.

Technical description:

- Available for nominal voltages and nominal voltage ranges from 3 to 36 kV
- Can be used with a rated frequency of 50 Hz
- For reliable phase comparison, a rated frequency of 49.9 - 50.1 Hz is required, with a maximum frequency drift of 10 mHz/s
- Self-test feature
- Automatic switch-off device
- Green, red and yellow LED display
- Removable contact electrode top piece, as forked electrode

The SPPC Type single-pole comparator is designed to meet international Standard IEC 61481.

Single-pole Phase Comparator SPPC

The **single-pole phase comparator SPPC** is available for various voltages and ranges of nominal voltages. Depending on type, the phase comparator can also be used when there is precipitation.



No.	Nominal voltage U_n (kV)	Total length L_e (mm)	Insertion depth A_i (mm)	Diameter of insulating element d (mm)	Suitable for use under precipitation
364 788 001	6 - 12	1440	575	24	-
364 825 001	6 - 12	1440	575	24	■
364 825 002	6 - 12	1640	775	24	■
364 788 004	10	1040	349	24	-
364 788 002	12 - 24	1640	775	24	-
364 825 003	12 - 24	1640	775	24	■
364 788 003	24 - 36	1640	775	24	-
364 825 004	24 - 36	1640	775	24	■

Single-pole Phase Comparator SPPC, Switchable

The **single-pole phase comparator SPPC** is available for various ranges of nominal voltages. Depending on type, the phase comparator can also be used when there is precipitation. This phase comparator can also be switched between three nominal voltage ranges using the voltage range switching ring. This allows a larger system range to be covered with the same interference field resistance.



No.	Nominal voltage level I	Nominal voltage level II	Nominal voltage level III	Total length	Insertion depth	Diameter of insulating element	Suitable for use under precipitation
	U_n (kV)	U_n (kV)	U_n (kV)	L_o (mm)	A_i (mm)	d (mm)	
364 750 001	6 - 12	12 - 24	24 - 36	1640	775	24	■
364 830 001	6 - 12	12 - 24	24 - 36	1640	775	24	-



Deltameter 5

The Deltameter 5 is a measuring device for indicating the voltage difference between two phases.

When connecting different medium voltage systems together, protective devices may be actuated as a result of incorrect phase and voltage positions, although phase position tests with IEC 61481 phase comparators have indicated „phase coincidence“. In cases like these, the Deltameter 5 can be used to supplement the phase position tests with phase comparators. The Deltameter 5 indicates the quantitative voltage difference between two phases, on a four-digit segment display with a resolution of 10 V. The Deltameter 5 thus provides a highly precise decision-making tool for the available switching operations.

Technical description:

- Double pole type with two insulating poles and two convenient handles
- For use on a.c. systems with a nominal frequency of 50 Hz and nominal voltage from 1 to 13 kV
- Can be used when there is precipitation
- 7-segment 4-digit LED display, digit height 14 mm
- 10 V resolution
- $\pm 5\%$ accuracy on a measured value of +30 V
- Connecting cable length 1,000 mm
- Artificial leather case included

No.	Nominal voltage U_n (kV)	Total length L_e (mm)	Insertion depth A_i (mm)
930 450 001	1 - 13	1190	520

In-service Tests for Phase Comparators

Depending on national regulations in the country concerned, in-service tests are required for phase comparators with nominal voltages above 1 kV. In Germany, these are obligatory under the „Electrical installations and equipment“ (BGV A3) accident prevention rule. Voltage detectors must then, within a maximum period of six years, be submitted to another in-service test and specified checks. The appendix of Standard IEC 61481 gives a description of these tests.

PFISTERER have been successfully carrying out these in-service tests on their own test equipment for many years. The voltage detectors are tested according to the specifications, and immediately adjusted if necessary. Whenever extensive repairs are necessary, we give a cost quotation.

When the tests are completed, the results are documented in detail.

To request an In-service test, please contact your local sales agency.

For customers in Germany please use the following mailing address:

PFISTERER Kontaktsysteme GmbH & Co. KG
 Bereich Wiederholungsprüfung
 Bahnhofstraße 30
 89547 Gerstetten - Gussenstadt
 Germany



No.	Description
200 000 012	Double-pole phase comparators
200 000 016	Phase comparator SPPC - single-range
200 000 017	Phase comparator SPPC - multi-range

In-service Tests for Phase Comparators

Operating Poles

PFISTERER offers various types of operating poles for different applications. Operating poles are hand-held devices for operating and testing live components.

Insulating Poles

These insulating poles are suitable for use on installations with nominal voltages up to 110 kV.

Technical description:

- Receiving head with roller locking device
- Suitable for indoor and outdoor installations, but not when there is precipitation
- Red ring
- Hand guard
- Insulating poles made of fibre-glass reinforced polyester tube, colour yellow

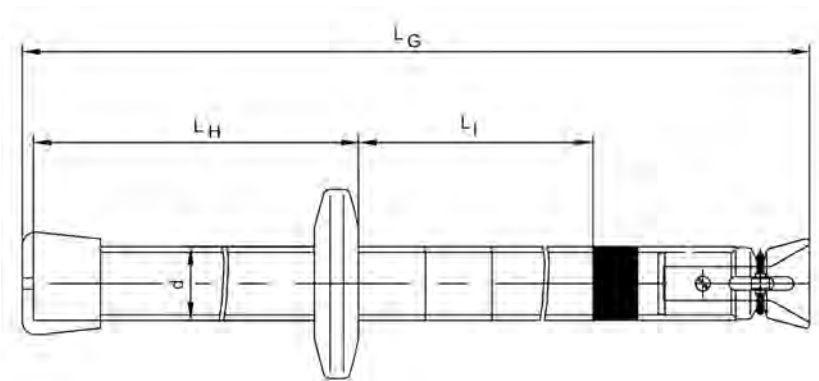

No.	Nominal voltage	Total length	Length of insulating element	Length of handle	Diameter of insulating element
	U_n (kV)	L_G (mm)	L_I (mm)	L_H (mm)	d (mm)
363 810 810	30	1038	525	450	33
363 810 811	30	1538	525	605	33
363 810 812	30	2038	525	705	33
363 810 816	110	2038	1300	685	33
363 815 818	110	3038	1300	800	43

Insulating Poles, Telescopic Type

These insulating poles are suitable for use on installations with nominal voltages up to 110 kV.

Technical description:

- Continuous telescoping adjustment
- Receiving head with roller locking device
- Suitable for indoor and outdoor installations, but not when there is precipitation
- Red ring
- Hand guard
- Insulating poles made of fibre-glass reinforced polyester tube, colour yellow

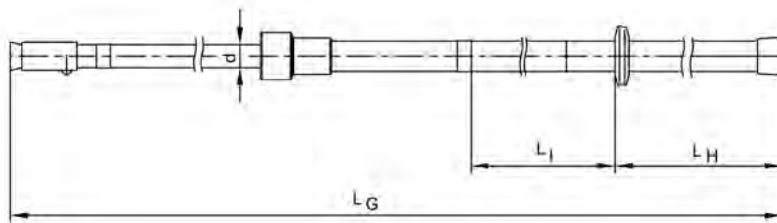

No.	Nominal voltage U_n (kV)	Total length L_G (mm)	Length of insulating element L_I (mm)	Length of handle L_H (mm)	Transporting length L_T (mm)	Diameter of insulating element d (mm)
362 808 808	30	3200	525	915	1965	43



Switching Poles

These switching poles are suitable for use on installations with nominal voltages up to 110 kV.

Technical description:

- Suitable for indoor and outdoor installations
- Plastic actuating bolt and hand guard
- End cap made of non-slip rubber
- Switching pole made of glass-fibre reinforced polyester tube, colour yellow

These switching poles are designed to Standard DIN VDE 0681 Part 1 and 2.

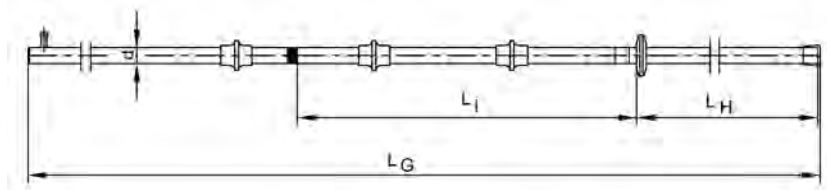

No.	Nominal voltage U_n (kV)	Suitable for use under precipitation	Total length L_G (mm)	Length of insulating element L_I (mm)	Length of handle L_H (mm)	Diameter of insulating element d (mm)
364 035 004	30	-	1008	525	400	33
364 827 006	30	■	1008	525	400	33
364 035 005	30	-	1508	525	530	33
364 827 001	30	■	1508	525	470	33
364 035 035	30	-	2008	525	635	33
364 827 002	30	■	2008	525	470	33
364 035 036	30	-	2508	525	750	33
364 035 037	30	-	3008	525	750	33
364 827 003	60	■	2508	900	850	33
364 035 042	110	-	2008	1300	635	33
364 035 043	110	-	2508	1300	750	33
364 827 004	110	■	3008	1300	950	33
364 035 008	110	-	3508	1300	750	33
364 827 007	110	■	4008	1300	1400	33
364 827 008	110	■	5008	1300	1400	33

Insulating Working Poles

These insulating working poles are designed for use as operating poles on various jobs carried out on or near live components.

Insulating working poles are available in various lengths. More details available on request.



Pruning saw poles

Pruning saw poles used to saw off individual branches that have grown into the danger area around electrical installations. For this purpose, special sawing devices are attached to insulating poles made of fibre-glass reinforced polyester tube.

No.	Version
360 488 000	0008



Lopping Poles

Lopping poles used to cutting off individual branches that have grown into the danger area around electrical installations. For this purpose, special cutting devices are attached to insulating poles made of fibre-glass reinforced polyester tube.

No.	Version
360 488 000	0009



Ice-removing Poles

Ice-removing poles used to remove ice from electrical installations. For this purpose, a special hook is attached to insulating poles made of fibre-glass reinforced polyester tube.

No.	Version
360 488 000	0010



Cable Pulling Hook

This **cable pulling hook** is used for moving live superflexible cables, especially in mining applications.

No.
362 000 001



Insulating Working Poles



All-insulated Rescue Hook

For rescuing persons from the danger area around live system components after an accident. These rescue hooks have a dielectric strength of 80 kV / mm. Type H is for indoor use only, Type N can be used either in indoor or outdoor installations.

No.	Type	Range of application	Length (mm)
360 491 001	N	< 1000 V	1000
360 491 002	H	< 30000 V	1650

Fuse-tongs, 20° angled

This fuse-tong is suitable for replacing high-voltage fuses in switchgear.

Technical description:

- Rapid adjustment using the double-threaded spindle
- Tilted clamping jaws
- Mechanical overload coupling protects the head from fracture
- Not to be used when there is precipitation



The fuse tong is designed to Standard DIN VDE 0681 Parts 1 and 3.

No.	Nominal voltage	Total length	Length of insulating element	Length of handle	Diameter of insulating element
	U_n (kV)	L_G (mm)	L_I (mm)	L_H (mm)	d (mm)
363 280 002	30	1251	525	460	33

Earthing Poles

Earthing poles are used for connecting earthing and short-circuiting devices. To do this, the line clamps are brought up to the connection point on the dead conductor.

Technical description:

- Line clamps held by spindle and cross-pin
- A receiving head with roller locking device allows the earthing pole to be easily attached/detached from the line clamp
- Earthing poles made of glass-fibre reinforced polyester tube, coloured yellow
- Black mark indicates the required insulation gap
- End cap made of non-slip rubber

Earthing Poles

Single-piece earthing poles.



No.	Pole length	Diameter of insulating element
	(mm)	d (mm)
364 153 153	1038	33
364 153 154	1538	33
364 153 155	2038	33
364 156 156	2538	43
364 156 157	3038	43
364 156 158	3538	43

Telescopic Earthing Poles

Telescopic earthing poles.



No.	Pole length extended	Transporting length	Diameter of insulating element
	L (mm)	L _r (mm)	d (mm)
364 169 169	1565	890	43
364 169 170	2030	1155	43
364 169 171	2464	1390	43
364 169 172	2905	1540	43
364 169 173	3405	1790	43
364 169 174	3905	2040	43
364 169 175	4415	2540	43
364 169 597	5917	4040	43

Earthing Poles with Line Clamp P1

Single-piece earthing poles with fixed line clamp P1. The one-piece design allows earth fittings to be attached/detached easily, even in places that are difficult to access. The yellow earthing poles also clearly mark the work location.

No.	Pole length (mm)	Diameter of insulating element d (mm)
364 115 001	1500	33



Earthing Poles with Line Clamp P7

Single-piece earthing poles with fixed line clamp P7. The one-piece design allows earth fittings to be attached/detached easily, even in places that are difficult to access. The yellow earthing poles also clearly mark the work location.

No.	Pole length (mm)	Diameter of insulating element d (mm)
364 212 001	2500	43



Telescopic Earthing Poles with Line Clamp P9

Earthing poles, telescopic type, with fixed parallel line clamp P9. This design allows earth fittings to be attached/detached easily, even in places that are difficult to access. The yellow earthing poles also clearly mark the work location.

No.	Pole length extended	Transporting length	Diameter of insulating element
	L (mm)	L _T (mm)	d (mm)
364 084 084	2185	1470	43
364 084 086	3050	1845	43
364 084 087	3540	2095	43
364 084 001	4040	2345	43
364 084 089	4560	2845	43
364 084 002	6065	4190	43





Telescopic Earthing Poles with Line Clamp P8

Earthing poles, telescopic type, with fixed HV line clamp P8.

This design allows earth fittings to be attached/detached easily, even in places that are difficult to access. The yellow earthing poles also clearly mark the work location.

No.	Pole length extended	Transporting length	Diameter of insulating element
	L (mm)	L _T (mm)	d (mm)
364 112 114	3050	1700	43
364 112 115	3540	1950	43
364 112 116	3950	2200	43
364 112 003	4460	2700	43
364 112 004	6650	3685	43

Two-piece Earthing Poles with Phase Fixed Point

This **two-piece earthing pole with downward aluminium phase fixed point** makes it easier to attach earthing and short-circuiting devices at high working positions on outdoor switchgear.

This two-piece earthing pole is attached to the phase fixed point, tube or wire, and then tightened. The earthing pole remains attached throughout the whole earthing process. A single-pole earthing and short-circuiting device with separate earthing pole can then be attached to the downward phase fixed point on the two-piece earthing pole.

Technical description:

- The earthing and short-circuiting device can be used for short-circuit currents up to 29.5 kA / 1 s (wire cross-section 150 mm²)
- Working heights up to 9 m possible
- Easy handling thanks to shorter ground wire
- Shorter, weight-saving ground wire
- The earthed working location is very clearly marked by the attached earthing pole
- Aluminium downward fixed phase point
- Suitable earthing poles:
 - 364 112 115 (with line clamp P8)
 - 364 169 173 (without line clamp)
- Diameter of insulating part: 43 mm

Earthing device to connect phase fixed point to ground potential need to be ordered separately.

No.	Version	Total length L _e (mm)	Carrying length (mm)	Line clamp	
364 116 000	0001	4500	3107	P7	1
364 116 000	0002	5000	3107	P7	1
364 116 000	0003	5500	3107	P7	1
364 116 000	0004	6000	3107	P7	1
364 116 000	0005	6500	3494	P7	1
364 116 000	0006	7000	3494	P7	1
364 116 000	0007	7500	4494	P7	1
364 116 000	0008	8000	4494	P7	1
364 116 000	0010	4500	3107	P8	2
364 116 000	0011	5000	3107	P8	2
364 116 000	0012	5500	3107	P8	2
364 116 000	0013	6000	3107	P8	2
364 116 000	0014	6500	3501	P8	2
364 116 000	0015	7000	4001	P8	2
364 116 000	0016	7500	4501	P8	2
364 116 000	0017	8000	5001	P8	2



1



2



Earthing Poles for Railway Systems

Earthing poles for railway systems are used for connecting railway grounding devices. To do this, the earthing terminals are brought up to the contact wire. These earthing poles are marked with red stripes on a white background. This allows optimum identification of the work location.

Technical description:

- Contact wire earthing terminals held by spindle and cross-pin
- A receiving head with roller locking device allows the earthing pole to be easily attached/detached from the contact wire earthing terminal
- Robust construction for use in railway applications

Telescopic Earthing Poles, two-piece

Earthing poles for railway systems, in two-piece design. These earthing poles are used mainly for transformers and railway power lines. They are continuously adjustable.



No.	Length range (m)	Pole length extended L (mm)	Transporting length L _T (mm)	Insulating length L _I (mm)	Weight (kg)	DB no.	DB drawing number
362 744 001	1,8 - 3,0	3500	1800	500	3.8	00157507	3 Ebgw 01.17
362 744 744	2,6 - 5,0	5000	2600	500	3.8	00157497	3 Ebgw 01.12

Telescopic Earthing Poles, three-piece

Earthing poles for railway systems, in three-piece design. The top area of the earthing pole is continuously adjustable. The connection between the earthing pole and the contact wire earthing terminal can be fixed using a slider. The earthing pole can thus be used to mark the work location.



No.	Length range (m)	Pole length extended L (mm)	Transporting length L _T (mm)	Insulating length L _I (mm)	Weight (kg)
362 745 745	2,0 - 5,0	5080	2000	500	5.2
362 745 002	3,2 - 7,0	7000	3200	500	5.2

Earthing Poles, five-piece

Earthing pole for railway systems in five-piece design. Because of the short carrying length, this type is suitable for transport in all common passenger vehicle types. The connection between the earthing pole and the contact wire earthing terminal can be fixed using a slider. The earthing pole can thus be used to mark the work location.

No.	Length range (m)	Pole length L (mm)	Transporting length L _T (mm)	Insulating length L _I (mm)	DB no.	DB drawing number
364 784 001	4,9	4892	1100	500	00157498	3 Ebgw 01.22





Earthing and Short-circuiting Devices

When working on electrical switchgear, **earthing and short-circuiting devices** are essential components for ensuring user safety and protecting the switchgear. For earthing, and to set up a temporary short-circuit-proof link to parts of the switchgear, you also need tools that meet the highest quality and reliability requirements.

PFISTERER has been developing and producing earthing and short-circuiting devices for decades, and symbolises this kind of quality and reliability. Through an optimised process, we are able to supply the widest variety of types of earthing and short-circuiting devices.

Technical description:

- Earthing and short-circuiting devices for short-circuit currents from 4.9 to 29.6 kA/s
- Copper earthing and short-circuiting cables can be supplied with cross-section from 25 mm² to 150 mm²
- Individual conductors can be replaced by the appropriate connecting cluster
- Optimised protection from damage and atmospheric influences on cable ends
- Components suitable for different types of application
- Components dimensioned for high short-circuit currents

Our earthing and short-circuiting devices are made extensively to IEC 61230 standard, and type-tested on approved test equipment.

Our earthing and short-circuiting devices are available in four basic types:

- **Single-pole** earthing and short-circuiting device
- **Double-pole** earthing and short-circuiting device with two short-circuiting cables and one earthing cable
- **Three-pole** earthing and short-circuiting device with three short-circuiting cables and one earthing cable
- **Four-pole** earthing and short-circuiting device with four short-circuiting cables and one earthing cable

Cross-section of copper conductor mm ²	Extremely reliable short-circuit current I _k indicated in A for a period of				
	10 s	5 s	2 s	1 s	≤ 0.5 s
25	1600	2200	3500	4900	7000
35	2200	3100	4900	6900	10000
50	3100	4400	7000	9900	14000
70	4400	6200	9800	13800	19500
95	5900	8400	13200	18700	26500
120	7500	10600	16700	23700	33500
150	9400	13200	20900	29600	42000

A few basic types are shown below, other variants with different cross-sections, terminals and lengths are available on request.

Single-pole Earthing and Short-circuiting Cables

Utmost flexibility for assembling customer-specific earthing and short-circuiting devices. With a range of more than 25 line and earth clamps, conductor cross-sections are available from 25 to 150 mm² in any length.

The standard conductor lengths are:
Earthing cable: c = 5,000 mm

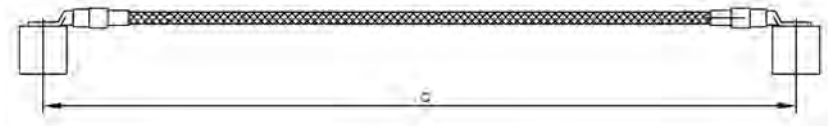

No.	Version	Cable cross section	Max. short circuiting current
		(mm ²)	I _k 1s (kA)
369 201 001	0024	25	4.9
369 201 001	0029	35	6.9
369 201 001	0001	50	9.9
369 201 001	0113	70	13.8
369 201 001	0002	95	18.7
369 201 001	0115	120	23.7
369 201 001	0520	150	29.6

Single-pole Earthing and Short-circuiting Devices Type P3-U3

Utmost flexibility for assembling customer-specific earthing and short-circuiting devices. With a range of more than 25 line and earth clamps, conductor cross-sections are available from 25 to 150 mm² in any length.

The standard conductor lengths are:
Earthing cable: c = 5000 mm

Possible connections:

Ball pin: Ø 20 mm
T-Bolt: Ø 15 mm
Circular conductor: Ø 20 mm
Flat conductor: Ø 20 mm



No.	Version	Cable cross section	Max. short circuiting current
		(mm ²)	I _k 1s (kA)
369 201 001	1419	25	4.9
369 201 001	0434	35	6.9
369 201 001	0669	50	9.9
369 201 001	0674	70	13.8
369 201 001	0678	95	18.7



Single-pole Earthing and Short-circuiting Devices Type P5-U5

Utmost flexibility for assembling customer-specific earthing and short-circuiting devices. With a range of more than 25 line and earth clamps, conductor cross-sections are available from 25 to 150 mm² in any length.

The standard conductor lengths are:
Earthing cable: c = 5000 mm

Possible connections:

Ball pin: Ø 25 mm
T-Bolt: Ø 20 mm
Circular conductor: Ø 25 mm
Flat conductor: Ø 20 mm

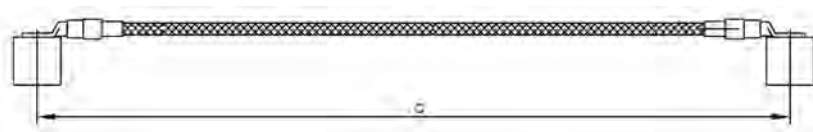

No.	Version	Cable cross section (mm ²)	Max. short circuiting current I _k 1s (kA)
369 201 001	1421	25	4.9
369 201 001	0950	35	6.9
369 201 001	0701	50	9.9
369 201 001	0705	70	13.8
369 201 001	0146	95	18.7
369 201 001	0713	120	23.7

Three-pole Earthing and Short-circuiting Cables

Utmost flexibility for assembling customer-specific earthing and short-circuiting devices. With a range of more than 25 line and earth clamps, conductor cross-sections are available from 25 to 150 mm² in any length.

The standard conductor lengths are:

Short-circuiting cables: a = b = d = 600 mm

Earthing cable: c = 1,500 mm

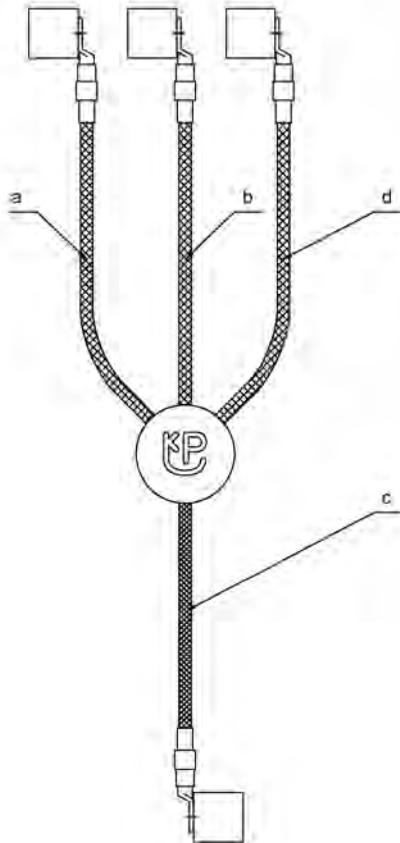

No.	Version	Cable cross section	Max. short circuiting current
		(mm ²)	I _k 1s (kA)
369 203 001	0062	25 / 25	4.9
369 203 001	1539	35 / 35	6.9
369 203 001	0020	50 / 25	9.9
369 203 001	0066	70 / 35	13.8
369 203 001	0067	95 / 35	18.7
369 203 001	0697	120 / 50	23.7
369 203 001	0700	150 / 50	29.6



Three-pole Earthing and Short-circuiting Devices Type P3-U3

Utmost flexibility for assembling customer-specific earthing and short-circuiting devices. With a range of more than 25 line and earth clamps, conductor cross-sections are available from 25 to 150 mm² in any length.

The standard conductor lengths are:
 Short-circuiting cables: a = b = d = 600 mm
 Earthing cable: c = 1,500 mm

Possible connections:

Ball pin: Ø 20 mm
 T-Bolt: Ø 15 mm
 Circular conductor: Ø 20 mm
 Flat conductor: Ø 20 mm

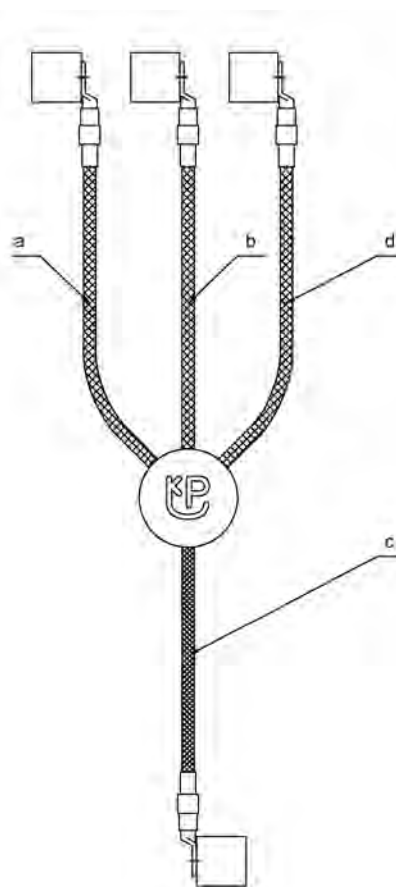

No.	Version	Cable cross section	Max. short circuiting current
		(mm ²)	I _k 1s (kA)
369 203 001	1245	25 / 25	4.9
369 203 001	0033	35 / 35	6.9
369 203 001	0829	50 / 25	9.9
369 203 001	0334	70 / 35	13.8
369 203 001	0830	95 / 35	18.7

Three-pole Earthing and Short-circuiting Devices Type P5-U5

Utmost flexibility for assembling customer-specific earthing and short-circuiting devices. With a range of more than 25 line and earth clamps, conductor cross-sections are available from 25 to 150 mm² in any length.

The standard conductor lengths are:

Short-circuiting cables: a = b = d = 600 mm

Earthing cable: c = 1,500 mm

Possible connections:

Ball pin: Ø 25 mm

T-Bolt: Ø 20 mm

Circular conductor: Ø 25 mm

Flat conductor: Ø 25 mm

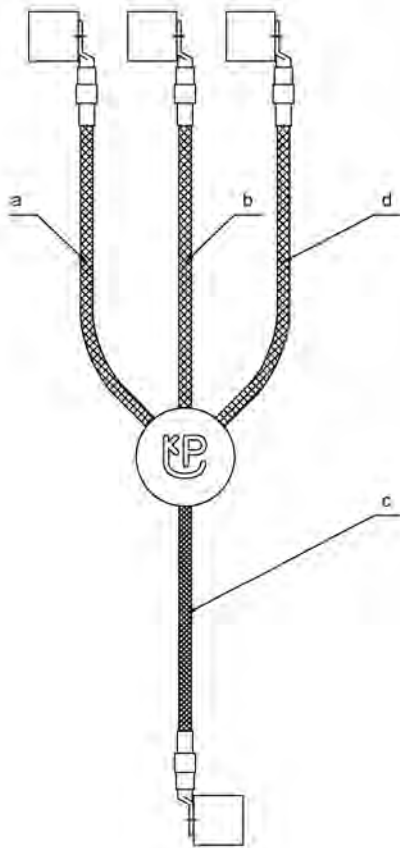

No.	Version	Cable cross section	Max. short circuiting current
		(mm ²)	I _k 1s (kA)
369 203 001	1251	25 / 25	4.9
369 203 001	1252	35 / 35	6.9
369 203 001	0260	50 / 25	9.9
369 203 001	0080	70 / 35	13.8
369 203 001	0077	95 / 35	18.7
369 203 001	0009	120 / 50	23.7



Three-pole Earthing and Short-circuiting Devices Type P2-U5

Utmost flexibility for assembling customer-specific earthing and short-circuiting devices. With a range of more than 25 line and earth clamps, conductor cross-sections are available from 25 to 150 mm² in any length.

The standard conductor lengths are:
 Short-circuiting cables: a = b = d = 600 mm
 Earthing cable: c = 1,500 mm

Possible connections:

Line clamp:
 circular conductor: Ø 6-32 mm

Earth clamp:
 Ball pin: Ø 25 mm
 T-Bolt: Ø 20 mm
 Circular conductor: Ø 25 mm
 Flat conductor: Ø 25 mm

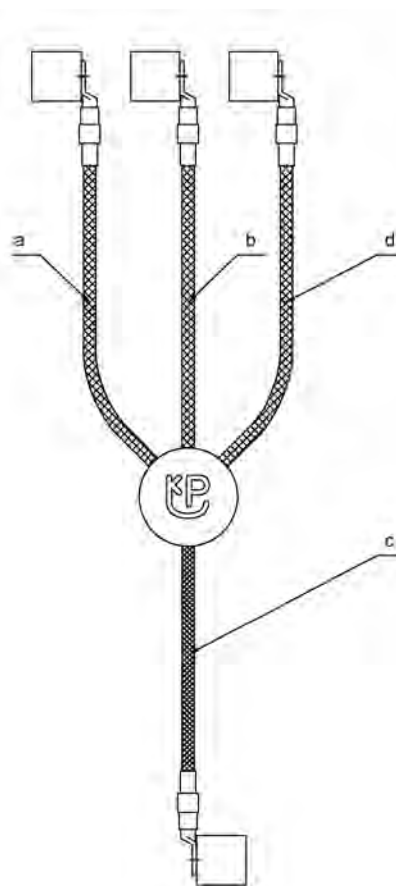

No.	Version	Cable cross section	Max. short circuiting current
		(mm ²)	I _k 1s (kA)
369 203 001	1253	25 / 25	4.9
369 203 001	1254	35 / 35	6.9
369 203 001	1255	50 / 25	9.9
369 203 001	1256	70 / 35	13.8
369 203 001	1257	95 / 35	18.7
369 203 001	1258	120 / 50	23.7

Earth Fittings for Medium Voltage Overhead Lines

This three-pole earthing and short-circuiting device is designed for use on medium voltage overhead lines. The fixed earthing poles allow rapid attachment and removal of the line clamps and also mark the work location.

Technical description:

- Three-pole earthing and short-circuiting device for use on medium voltage overhead lines
- Line clamps P1 are fixed to these earthing poles
- Length of short-circuiting cables: 1.5 m
- Ground wire length: 11 m
- Earth end can be connected to an earthing spike

No.	Version	Cable cross section	Max. short circuiting current
		(mm ²)	I_k 1s (kA)
369 203 001	1036	50	9.9



Earthing and Short-circuiting Devices for Low Voltage

Our low-voltage **earthing and short-circuiting devices** are used in low-voltage overhead lines and low-voltage switchgear, for example in cable distribution cabinets.

All-insulated Earthing and Short-circuiting Devices

This all-insulated earthing and short-circuiting device is designed for use on low voltage overhead lines.



Technical description:

- All-insulated suspension clamps for conductor Ø 314 mm
- Suspension clamp with probe tip and LED indicator for voltage indication
- Earthing and short-circuiting cables in 600 mm wire cable lengths
- Glass-fibre reinforced polyester tubes in 500 and 800 mm tube lengths
- Transparent insulating handles with bending protection
- Insulated screw-type connecting cluster

No.	Cable cross section (mm ²)	Max. short-circuit current I _k 1 s (A)	Number of suspension clamps	Length of insulating rods (mm)
360 528 528	25	4900	4	3 x 500 + 1 x 800
360 528 529	25	4900	5	4 x 500 + 1 x 800
360 528 530	25	4900	6	5 x 500 + 1 x 800



All-insulated Earthing and Short-circuiting Devices with Line Clamp P1

This earthing and short-circuiting device is designed for use on low voltage overhead lines with high short-circuit currents.

Technical description:

- Line clamp P1 fixed to handle
- Handle for easy handling

No.	Cable cross section (mm ²)	Max. short-circuit current I _k 1 s (A)	Number of suspension clamps
360 528 531	35	6900	5

Earthing and Short-circuiting Devices for Low Voltage Distribution Boards

This earthing and short-circuiting device is designed for use on low-voltage distribution boards, cable distribution cabinets and fuse boxes. It is supplied as a set, consisting of the following components. Different contents available on request.

Technical description:

The set is made up of the following parts:

- 2 earthing and short-circuiting devices to standard DIN VDE 0683 Part 100, cable cross-section: 25 mm²
- Cable lengths: a = 300 mm; b = 600 mm; c = 800 mm; d = 1000 mm
- Screw-in thread for earthing cartridges, slotted cable lug for earth clamps
- 2 MP clamps for busbars with flexible handle and 2 spindle settings, 623 695 001
- 6 earthing cartridges for NH size 1 – 3, 364809001
- 1 earthing pole (350 mm) for inserting the earthing cartridges, or attaching the earthing and short-circuiting device
- 3 earthing inserts for DIAZED fuse holders, 623 688 001
- 3 earthing cartridges for NH size 00, 364 754 002
- 1 plastic carrying case with foam lining and user instructions, 364 558 001



No.

364 866 001

Three-pole Earthing and Short-circuiting Devices

With electromagnetic locking.

For low-voltage distributing boards and cable distribution cabinets with LV-HRC fuse rails 500 V, DIN 43 623.

Technical description:

- 3 earthing cartridges with electromagnetic locking (size 1 to 3), 361 337 337
- Earthing and short-circuiting cables with screw-type connecting cluster
- Earth clamp type E2
- Suitable earth handle 364 778 002 has to be ordered separately

No.	Cable cross section (mm ²)	Cable length a (mm)	Cable length b (mm)	Cable length d (mm)	Cable length c (mm)	Weight (kg)
360 481 481	25	1000	750	500	250	2.7

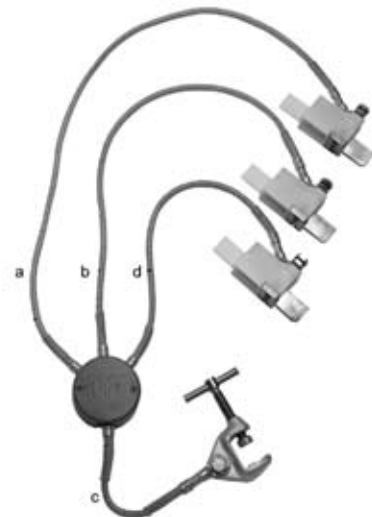

V
Earthing and Short-circuiting Devices

Special Earth Fittings

Besides the earthing and short-circuiting fittings for medium and high voltages, PFISTERER also offers **special earth fittings** for special applications.

Discharge Rods

Discharge rods are used for discharging induction and balance voltages from high voltage capacitors.



Technical description:

- Copper hook fixed to glass-fibre reinforced polyester tube, colour yellow
- Earthing cable with cable lug
- Insulation length $L_1 = 500$ mm
- Diameter of insulating element = 24 mm
- Copper hook length = 120 mm
- Copper hook diameter = 8 mm

Other types with other cable cross-sections and lengths are available on request.

No.	Version	Cable cross section	Cable length	Pole length
		(mm ²)	(mm)	L (mm)
363 800 000	0003	25	2000	1000
363 800 000	0004	25	3000	1500

Earthing Devices for Railway Systems

When working on the overhead lines of electric railways, you need earthing devices that meet the highest quality and reliability requirements.

PFISTERER has been developing and producing earthing devices for railway systems for decades, and symbolises this kind of quality and reliability. Through an optimised process, we are able to supply the widest variety of types of earthing devices.

Technical description:

- Earthing devices for long-distance railways with a.c. or d.c. voltage, for underground railways and trolley lines
- Copper earthing and short-circuiting cables available with cross-sections from 25 mm² to 150 mm²
- Earthing and short-circuiting devices available for profile-free earthing
- Optimised protection from damage and atmospheric influences on cable ends
- Components suitable for various types of application
- Components dimensioned for high short-circuit currents



Railway Earthing Devices for Overhead Lines

This railway earthing device is designed for use on overhead lines. It can be used for contact wire heights from 4.8 to 6.25 m. The use of rail earth clamp R50 allows profile-free earthing, and diesel locomotive operation is then possible in the earthed state.

Technical description:

Depending on type, this railway earthing device is made up of the following components:

- 1 contact wire earth clamp, 361 499 001
- 1 rail earth clamp, 363 322 005
- 1 earthing cable, 8.5 or 12 m long, 362 138 138
- 1 suspension hook, 360 453 453
- 1 telescopic type earthing pole (two-piece), 362 744 744



No.	Description	Length of earthing cable (m)	Profile-free	DB no.	DB drawing number
364 845 001	with telescopic earthing pole 2-piece	8.5	-	00237111	3 Ebgw 01.11
364 845 006	without earthing pole	8.5	-	-	-
364 845 002	with telescopic earthing pole 2-piece and suspension hook for earth wire	12	■	00237112	3 Ebgw 01.11
364 845 005	without earthing pole with suspension hook for earth wire	12	■	-	-



Railway Earthing Devices for Overhead Lines (Automobile Type)

This railway earthing device is designed for mobile use and is suitable for transporting in automobiles and vehicles of the emergency services or fire departments. The use of rail earth clamp R50 allows profile-free earthing, and diesel locomotive operation is then possible in the earthed state. The earthing pole and ratchet can be pulled off to mark the work location.

Technical description:

- Carrying length of the 5-piece earthing pole about 1,100 mm
- Short-circuit-proof $I_k = 36.5 \text{ kA} / 0.12 \text{ s}$

Depending on type, this railway earthing device is made up of the following components:

- 1 plug-in type earthing pole, No. 364 784 001
- 2 rail earth clamps, No. 363 322 005
- 2 contact wire earth clamps, No. 361 499 001
- 2 short-circuiting cables 50 mm^2 , length 8.5 m or 12 m, with red marker flag
- 1 carryingcase for earthing pole, No 364 786 001
- 1 carrying case for 2 earthing sets, No. 364 785 001



No.	Description	Length of earthing cable (m)	Profile-free	DB no.	DB drawing number
364 766 001	with plug-in type earthing pole, 5-piece	8.5	-	00237126	3 Ebgw 01.21
364 766 004	with plug-in type earthing pole, 5-piece	12	■	-	-

Railway Earthing Devices for Railway Power Lines

This railway earthing device is designed for use on railway power lines.

Technical description:

It is made up of the following components:

- 1 Telescopic type earthing pole, two-piece, No. 362 744 001
- 1 Earth clamp U2, No. 361 346 001
- 1 contact wire earth clamp P50, with feeler bow, No. 363 418 003
- 1 short-circuiting cable 50 mm^2 , length 4 m



No.	Length of earthing cable (m)	DB no.	DB drawing number
363 571 571	4	00237107	3 Ebgw 01.23

Railway Earthing Devices for Transformers

This railway earthing device is designed for use on the transformers of overhead line poles.

Technical description:

It is made up of the following components:

- 1 telescopic type earthing pole, 362 744 001
- 2 earth clamps U2, 361 346 001
- 2 line clamps P4, 360 332 001
- 2 short-circuiting cables 50 mm², length 4 m

No.	Length of earthing cable (m)	DB no.	DB drawing number
364 844 001	4	00237124	3 Ebgw 01.16



Railway Earthing Devices for Construction Machines

This railway earthing device is suitable for the protective earthing of construction machines.

Technical description:

It is made up of the following components:



















- 1 earth terminal clamp U2, 361 346 001
- 1 rail earthing clamp R50, 363 32 005
- 1 short-circuiting cable 50 mm², length 12 m

No.	Length of earthing cable (m)	DB no.	DB drawing number
364 843 001	12	00237123	3 Ebgw 01.15



V
Earthing and Short-circuiting Devices for Railway Systems

Overview Earth Clamps





No.	Type	Max. cross section (mm ²)	 Ø (mm)	 Ø (mm)	 Ø (mm)	 Ø (mm)	 Ø (mm)	Max. short-circuit current I _k 1 s (kA)	Clamping range (mm)	Clamping width (mm)	Weight (g)
364 811 001	A1 	150	-	16	-	-	-	29.6	16	-	656
364 544 002	A2 	150	-	16 - 22	-	16 - 22	-	29.6	16 - 22	-	736
360 419 004	E2 	70	-	-	-	2 - 30	2 - 30	13.8	2 - 30	-	370
360 416 002	F1 	50	-	-	-	-	2 - 20	9.9	2 - 20	-	442
360 628 002	F2 	95	-	-	-	-	2 - 22	18.7	2 - 22	-	978
360 414 001	U1 	95	20	-	15	5 - 20	2 - 20	18.7	2 - 20	38	720
361 346 001	U2 	150	25	-	15	5 - 20	2 - 20	29.6	2 - 20	38	754
364 704 004	U3 	95	20	-	15	5 - 20	2 - 20	18.7	2 - 20	38	806
364 704 003	U4 	150	25	-	15	5 - 20	2 - 20	29.6	2 - 20	38	836
364 714 002	U5 	120	25	-	20	5 - 25	2 - 25	23.7	2 - 25	38	902
361 657 001	M12 	150	-	-	-	-	-	29.6	-	-	210
361 658 001	M16 	150	-	-	-	-	-	29.6	-	-	210
361 657 002	S12 	150	-	-	-	-	-	29.6	-	-	250
361 659 001	S16 	150	-	-	-	-	-	29.6	-	-	250

Overview Line Clamps





No.	Type	Max. cross section (mm ²)						Max. short-circuit current Ik 1 s (kA)	Clamping range (mm)	Clamping width (mm)	Weight (g)
			Ø (mm)	Ø (mm)	Ø (mm)	Ø (mm)	Ø (mm)				
364 904 001	P1	120	-	-	-	4 - 20	-	23.7	4 - 20	48	382
364 903 001	P2	150	-	-	-	6 - 32	-	29.6	6 - 32	57	526
360 330 002	P3	95	20	5 - 20	15	5 - 20	5 - 20	18.7	5 - 20	38	754
360 332 001	P4	120	25	5 - 20	15	5 - 20	5 - 20	23.7	5 - 20	38	782
360 333 002	P5	150	25	5 - 25	20	5 - 25	5 - 20	29.6	5 - 25	50	850
364 309 005	P6	70	-	-	-	4 - 23	4 - 23	13.8	4 - 23	27	440
363 245 006	P7	120	-	-	-	4.5 - 35	4.5 - 35	23.7	4.5 - 35	34	714
364 459 009	P8	150	-	-	-	10 - 85	-	29.6	10 - 85	40	886
360 335 003	P9	95	-	-	-	10 - 32	10 - 32	18.7	10 - 32	38	968
360 329 001	P10	50	-	-	-	5 - 16	5 - 16	9.9	5 - 16	40	722
360 335 004	P11	95	-	-	-	10 - 32	10 - 32	18.7	10 - 32	38	1010
363 091 297	P12	150	-	-	-	-	10 - 25	29.6	10 - 25	40	914

V
Line Clamps

Overview Rail Earth Clamps for Railway Systems

No.	Type	Max. cross section (mm ²)						Max. short-circuit current Ik 1 s (kA)	Clamping range (mm)	Clamping width (mm)	Weight (g)
			Ø (mm)	Ø (mm)	Ø (mm)	Ø (mm)	Ø (mm)				
363 322 005	R50 	50	-	-	-	-	-	40 (Ik 0.12s)	-	-	2128
364 901 001	R51 	70	-	-	-	-	-	13.8 (Ik 1s)	-	-	5000
364 868 001	R52 	50	-	-	-	-	-	40 (Ik 0.12s)	-	-	858

Overview Contact Wire Earth Clamps for Railway Systems

No.	Type	Max. cross section (mm ²)						Max. short-circuit current Ik 1 s (kA)	Clamping range (mm)	Clamping width (mm)	Weight (g)
			Ø (mm)	Ø (mm)	Ø (mm)	Ø (mm)	Ø (mm)				
363 418 003	P50 	120	-	-	-	4.5 - 35	-	23.7	4.5 - 35	34	814
361 499 001	P51 	50	-	-	-	Ri80 - 150	-	36.5 (Ik 0.12s)	-	30	1070
361 499 499	P52 	50	-	-	-	Ri80 - 150	-	36.5 (Ik 0.12s)	-	30	942
362 947 947	P53 	50	-	-	-	Ri80 - 150	-	23.3 (Ik 0.12s)	-	30	1968

Earth Clamps

PFISTERER offers an extensive range of earth clamps for earthing and short-circuiting devices (see overview). These earth clamps are offered in various types, which are designed for different earth connection variants in indoor and outdoor installations.

Technical description:

- Earth clamps available in clamping ranges from 2 to 25 mm
- Earth clamps available with short-circuit current carrying capacity up to 29.6 kA/1 s
- Compact, robust design
- Easy handling
- Connected to an earthing and short-circuiting device by an M12 screw

Universal Earth Clamps U1

Earth clamp with capstan-head screw for use at various earth connection points.

No.	Max. cross section of connected cable (mm ²)	Max. short-circuit current I _k 1 s (A)	Clamping range (mm)	Clamping width (mm)	Weight (g)
360 414 001	95	18700	2 - 20	38	720



Universal Earth Clamps U2

Earth clamp with capstan-head screw for use at various earth connection points. Suitable for higher short-circuit currents.

No.	Max. cross section of connected cable (mm ²)	Max. short-circuit current I _k 1 s (A)	Clamping range (mm)	Clamping width (mm)	Weight (g)
361 346 001	150	29600	2 - 20	38	754





Universal Earth Clamps U3

Earth clamp with handle for use at various earth connection points.

No.	Max. cross section of connected cable (mm ²)	Max. short-circuit current I_k 1 s (A)	Clamping range (mm)	Clamping width (mm)	Weight (g)
364 704 004	95	18700	2 - 20	38	806



Universal Earth Clamps U4

Earth clamp with capstan-head screw for use at various earth connection points.

No.	Max. cross section of connected cable (mm ²)	Max. short-circuit current I_k 1 s (A)	Clamping range (mm)	Clamping width (mm)	Weight (g)
364 704 003	150	29600	2 - 20	38	836



Universal Earth Clamps U5

Earth clamp with handle for use at various earth connection points.

No.	Max. cross section of connected cable (mm ²)	Max. short-circuit current I_k 1 s (A)	Clamping range (mm)	Clamping width (mm)	Weight (g)
364 714 002	120	23700	2 - 25	38	902



Earth Connection Sockets A1

Earth connection socket with wing screw for connection to a cylindrical earthing bolt.

No.	Max. cross section of connected cable (mm ²)	Max. short-circuit current I_k 1 s (A)	Clamping range (mm)	Weight (g)
364 811 001	150	29600	16	656

Earth Connection Sockets A2

Earth connection socket with capstan-head screw for connection to a cylindrical earthing bolt.

No.	Max. cross section of connected cable (mm ²)	Max. short-circuit current I_k 1 s (A)	Clamping range (mm)	Weight (g)
364 544 002	150	29600	16 - 22	736

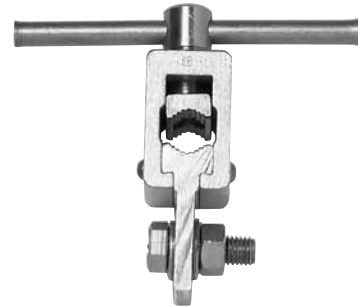

Earth Clamps E2

Earth clamp with capstan-head screw.

No.	Max. cross section of connected cable (mm ²)	Max. short-circuit current I_k 1 s (A)	Clamping range (mm)	Weight (g)
360 419 004	70	13800	2 - 30	370



Penetrating Earth Clamps F1

Earth clamp with capstan-head screw for use on coated masts. The cupped gripping point and tip are hardened to ensure reliable contact.

No.	Max. cross section of connected cable (mm ²)	Max. short-circuit current I_k 1 s (A)	Clamping range (mm)	Weight (g)
360 416 002	50	9900	2 - 20	442



Gösag Penetrating Earth Clamps F2

Earth clamp with capstan-head screw for use on coated masts. The cupped gripping point and tip are hardened to ensure reliable contact.

No.	Max. cross section of connected cable (mm ²)	Max. short-circuit current I_k 1 s (A)	Clamping range (mm)	Weight (g)
360 628 002	95	18700	2 - 22	978



V
Earth Clamps



Compression Cable Lugs with M12 / M16 Wing Nut

Earth connection through a compression cable lug with wing nut for connection to a thread bolt.

No.	Max. cross section of connected cable (mm ²)	Max. short-circuit current I _k 1 s (A)	Thread G	Weight (g)
361 657 001	150	29600	M12	210
361 658 001	150	29600	M16	210



Compression Cable Lugs with S12 / S16 Wing Screw

Earth connection through a compression cable lug with wing screw for threaded connection.

No.	Max. cross section of connected cable (mm ²)	Max. short-circuit current I _k 1 s (A)	Thread G	Weight (g)
361 657 002	150	29600	M12	250
361 659 001	150	29600	M16	250



Multi-contact Connection Devices U2

Suitable for connecting to 25 mm ball pins.

The multi-contact connection device consists of copper bar, universal clamp no. 361 346 001, and two 25 mm ball pins no. 360 938 095.

No.	Max. short-circuit current I _k 1 s (A)	Short-circuiting bar L x B (mm)	Short-circuiting bar thickness (mm)	Weight (kg)	DB no.	DB drawing number
363 463 463	29600	200 x 40	6	1.7	00157498	3 Ebgw 01.27



Multi-contact Connection Devices A1

With earth terminal socket A1 and three cylindrical earthing bolts with annular groove. The triple earth connection serves to earth and short circuit three single-pole earthing and short-circuiting cables.

Short-circuiting bar and connecting angle of Cu/Sn, 40 x 8 mm. Total length 195 mm.

No.	Max. short-circuit current I _k 1 s (A)	Short-circuiting bar L x B (mm)	Short-circuiting bar thickness (mm)	Weight (kg)
364 900 001	29600	195 x 40	8	1.2

Multi-contact Connection Devices A2

With earth terminal socket A2 and three cylindrical earthing bolts with annular groove. The triple earth connection serves to earth and short circuit three single-pole earthing and short-circuiting cables. Short-circuiting bar and connecting angle of Cu/Sn, 40 x 8 mm. Total length 195 mm.



No.	Max. short-circuit current I_k 1 s (A)	Short-circuiting bar L x B (mm)	Short-circuiting bar thickness (mm)	Weight (kg)
364 899 001	29600	195 x 40	8	1.3



Rail Earthing Clamps

PFISTERER offers a range of rail earthing clamps for railway lines.



Rail Earth Clamps R50

This rail earth clamp is suitable for all rail base gauges. The small overall height (35 mm below the rail base) means there is no need to remove gravel. A separate handle allows easy placing of the clamp and protects the earth wire connection. When tightening the clamp, the annular cutting edge cuts through layers of dirt and oxide, thus ensuring a reliable contact. The counter surface is a hardened metal tip, which is spring-mounted and insulated. The clamp is therefore flame-resistant in the event of a short circuit.

No.	Max. cross section of connected cable (mm ²)	Max. short-circuit current I _k 0,12 s (A)	With ratchet	Weight (g)	DB no.	DB drawing number
363 322 005	50	40000	■	2128	00157500	3 Ebgw 01.13
363 322 006	50	40000	-	1706	-	-



Rail Earth Clamps R51

This rail earth clamp is designed as an earthing magnet for use on trolley lines.

No.	Max. cross section of connected cable (mm ²)	Max. short-circuit current I _k 1 s (A)	Weight (g)
364 901 001	70	13800	5000



Rail Earth Clamps R52

Suitable for grooved rails.

No.	Max. cross section of connected cable (mm ²)	Max. short-circuit current I _k 0,12 s (A)	Weight (g)
364 868 001	50	40000	858

Line Clamps

PFISTERER offers an extensive range of line clamps for earthing and short-circuiting devices (see overview). Depending on type, these line clamps are designed for connection to overhead lines or in switchgear.

Technical description:

- Line clamps available with clamping ranges from Ø 4 to 85 mm
- Line clamps available with short-circuit current carrying capacity up to 29.6 kA/1s
- Screw jack made of A2 stainless steel ensures reliable contact between terminal and conductor
- Compact, robust design
- Easy handling
- Connected to an earthing and short-circuiting device by an M12 screw

Line Clamps P1 for Overhead Lines

Line clamp for use on overhead lines. The tilting screw jack allows the line clamp to be attached even at places that are difficult to access. This line clamp is distinguished by its particularly easy handling.

Technical description:

- Swivelling spindle with swivel range $\pm 20^\circ$
- Base made of AISi10Mg(Fe)

No.	Max. cross section of connected cable (mm ²)	Max. short-circuit current I_k 1 s (A)	Clamping range (mm)	Clamping width (mm)	Weight (g)
364 904 001	120	23700	4 - 20	48	382



Line Clamps P2 for Overhead Lines

Line clamp for use on overhead lines. The tilting screw jack allows the line clamp to be attached even at places that are difficult to access. This line clamp is distinguished by its particularly easy handling.

Line clamp P2 has a larger clamping range than line clamp P1, which is similar in design.

Technical description:

- Swivelling spindle with swivel range $\pm 20^\circ$
- Base made of AISi10Mg(Fe)

No.	Max. cross section of connected cable (mm ²)	Max. short-circuit current I_k 1 s (A)	Clamping range (mm)	Clamping width (mm)	Weight (g)
364 903 001	150	29600	6 - 32	57	526



V
Line Clamps



Universal Line Clamps P3

Universal line clamp for various phase terminal points.

No.	Max. cross section of connected cable (mm ²)	Max. short-circuit current I_k 1 s (A)	Clamping range (mm)	Clamping width (mm)	Weight (g)
360 330 002	95	18700	5 - 20	38	754



Universal Line Clamps P4

Universal line clamp for various phase terminal points.

No.	Max. cross section of connected cable (mm ²)	Max. short-circuit current I_k 1 s (A)	Clamping range (mm)	Clamping width (mm)	Weight (g)
360 332 001	120	23700	5 - 20	38	782



Universal Line Clamps P5

Very short-circuit resistant line clamp for multiple applications.

No.	Max. cross section of connected cable (mm ²)	Max. short-circuit current I_k 1 s (A)	Clamping range (mm)	Clamping width (mm)	Weight (g)
360 333 002	150	29600	5 - 25	50	850



Line Clamps P6 for Overhead Lines

Line clamp for the slanting insert on overhead lines.

No.	Max. cross section of connected cable (mm ²)	Max. short-circuit current I_k 1 s (A)	Clamping range (mm)	Clamping width (mm)	Weight (g)
364 309 005	70	13800	4 - 23	27	440

V

Line Clamps

Line Clamps P7 for High-Voltage Overhead Lines

Line clamp for the slanting insert on high-voltage overhead lines.

No.	Max. cross section of connected cable (mm ²)	Max. short-circuit current I _k 1 s (A)	Clamping range (mm)	Clamping width (mm)	Weight (g)
363 245 006	120	23700	4,5 - 35	34	714



High-Voltage Line Clamps P8

Line clamp for connection to Al and Al/St lines, tubes and line contacts.

No.	Max. cross section of connected cable (mm ²)	Max. short-circuit current I _k 1 s (A)	Clamping range (mm)	Clamping width (mm)	Weight (g)
364 459 009	150	29600	10 - 85	40	886



Parallel Line Clamps P9

Line clamp for the slanting insert on high-voltage overhead lines. Due to the parallel setting of the clamping jaws, this line clamp is suitable for attaching at high positions, e.g. the cross arms of high-voltage poles.

No.	Max. cross section of connected cable (mm ²)	Max. short-circuit current I _k 1 s (A)	Clamping range (mm)	Clamping width (mm)	Weight (g)
360 335 003	95	18700	10 - 32	38	968



Parallel Line Clamps P10

Line clamp for the slanting insert on high-voltage overhead lines. Due to the parallel setting of the clamping jaws, this line clamp is suitable for attaching at high positions, e.g. the cross arms of high-voltage poles.

No.	Max. cross section of connected cable (mm ²)	Max. short-circuit current I _k 1 s (A)	Clamping range (mm)	Clamping width (mm)	Weight (g)
360 329 001	50	9900	5 - 16	40	722





Parallel Line Clamps P11

Line clamp for the slanting insert on high-voltage overhead lines. Due to the parallel setting of the clamping jaws, this line clamp is suitable for attaching at high positions, e.g. the cross arms of high-voltage poles.

This line clamp is also fitted with a guard stirrup. This can be used to prevent loosened line clamps from falling off.

No.	Max. cross section of connected cable (mm ²)	Max. short-circuit current I _k 1 s (A)	Clamping range (mm)	Clamping width (mm)	Weight (g)
360 335 004	95	18700	10 - 32	38	1010



Line Clamps P12 for Blade Contacts

Line clamp for use in all-insulated switchgear in retraction system Type R with blade contact of thickness 10, 16 and 20 mm and bead. The clamping jaws on the line clamp have fine-toothed grooves to ensure secure electrical contact and the best possible mechanical grip.

No.	Max. cross section of connected cable (mm ²)	Max. short-circuit current I _k 1 s (A)	Clamping range (mm)	Clamping width (mm)	Weight (g)
363 091 297	150	29600	10 - 25	40	914



Current Collector Clamps S100

Technical description:

- With tilting spindle
- For current sampling on overhead lines up to 300 mm²
- Screw jack with cross-pin for insulating pole 363 810 8xx
- Compact, simple robust design
- Spindle max. tightening torque = 25 Nm
- Conductor max. tightening torque = 6 Nm

No.	Swivel range	Conductor range (mm)	Continuous current-carrying capacity (A)	Max. cross section of connected cable (mm ²)	Weight (g)
360 328 010	± 20°	4 - 20	144	25	370

Contact Wire Earth Clamps

PFISTERER offers contact wire earth clamps for railway grounding devices. These contact wire earth clamps are designed for connection to various contact wires.

Technical description:

- Contact wire earth clamps for grooved, circular, sectional contact wires and double contact wires
- Jack screw made of A2 stainless steel ensures reliable contact between clamp and contact wire
- Compact, robust design
- Easy handling
- Earthing poles available for attaching all types of contact wire earth clamps



Contact Wire Earth Clamps P50

This contact wire earth clamp has a torsion-free earthing cable terminal at the front. The bow and thrust block are finely grooved to ensure secure electric contact and firm mechanical grip even when the conductors are corroded.

Technical description:

- Conductor range 4.5 – 35 mm
- With feeler bow for verifying absence of voltage to railway-internal specifications



No.	Max. cross-section of connected current cable (mm ²)	Max. short-circuit current I _k 1 s (A)	Clamping range (mm)	Clamping width (mm)	Weight (g)	DB no.	DB drawing number
363 418 003	120	23700	4,5 - 35	34	814	00157499	4 Ebgw 01.26

Contact Wire Earth Clamps P51

This contact wire earth clamp is fitted with a flexible spindle and is used for grooved, circular or profile wires.

Technical description:

- With feeler bow for easy insertion into the contact wire
- The spring-mounted thrust block is connected to the M12 connecting screw on the back by means of flexible copper tapes
- 361 499 002 with shortened sensor



No.	Max. cross-section of connected current cable (mm ²)	Max. short-circuit current I _k 0,12 s (A)	Contact wire	Clamping width (mm)	Weight (g)	DB no.	DB drawing number
361 499 001	50	36500	Ri 80 - 150	30	1070	00157471	3 Ebgw 01.14
361 499 002	50	36500	Ri 80 - 150	30	1010	-	-

V
Contact Wire Earth Clamps



Contact Wire Earth Clamps P52

This contact wire earth clamp is fitted with a rigid spindle and is used for grooved, circular or profile wires.

Technical description:

- With feeler bow for easy insertion into the contact wire
- The spring-mounted thrust block is connected to the M12 connecting screw on the back by means of flexible copper tapes

No.	Max. cross section of connected cable (mm ²)	Max. short-circuit current I _k 0,12 s (A)	Contact wire	Clamping width (mm)	Weight (g)
361 499 499	50	36500	Ri 80 - 150	30	942



Contact Wire Earth Clamps P53

This contact wire earth clamp is designed for use on double contact wires.

No.	Max. cross section of connected cable (mm ²)	Max. short-circuit current I _k 0,12 s (A)	Contact wire	Clamping width (mm)	Weight (g)
362 947 947	50	23300	Ri 80 - 150	30	1968

Earthing and Phase Fixed Points

PFISTERER provides a range of both earthing and phase fixed points.
Special phase fixed points on request.

Maximum installation torque

M10: 33 Nm
M12: 56 Nm
M16: 135 Nm



Ball Pin, Straight, with Outside Thread

According to DIN 48088 Part 1.

Technical description:

Railway authorities licence 4 Ebgw 01.24

- 360 938 095 DB-No. 00 157 503
- 360 938 939 DB-No. 00 157 495
- 360 384 003 DB-No. 00 621 849



No.	Max. cross section of connected cable (mm ²)	Head diameter (mm)	Thread length (mm)	Thread G	Width across flats (SW)	Max. short-circuit current I _k 1 s (A)	for line clamp
360 382 004	95	20	28	M12	22	18700	360 330 002
360 382 005	95	20	38	M12	22	18700	360 330 002
360 382 006	95	20	48	M12	22	18700	360 330 002
360 938 095	120	25	25	M16	27	23700	360 332 001 360 333 002
360 384 002	120	25	28	M12	27	23700	360 332 001 360 333 002
360 384 003	120	25	38	M12	27	23700	360 332 001 360 333 002
360 384 004	120	25	48	M12	27	23700	360 332 001 360 333 002
360 938 939	120	25	55	M16	27	23700	360 332 001 360 333 002

Ball Pin, Straight, with Inside Thread

According to DIN 48088 Part 1.



No.	Max. cross section of connected	Head diameter	Thread	Width across flats	Max. short-circuit current	for line clamp
	(mm ²)	(mm)	G	(SW)	I _k 1 s (A)	
612 633 005	95	20	M10	22	18700	360 330 002
612 633 004	95	20	M12	22	18700	360 330 002
615 820 001	120	25	M12	27	23700	360 332 001 360 333 002
615 822 001	120	25	M16	27	23700	360 332 001 360 333 002
360 786 003	70	20	M16	24	13800	360 330 002

Ball Pin, Angled, with Outside Thread



No.	Bracket	Max. cross section of connected cable	Head diameter	Thread length	Thread	Width across flats	Max. short-circuit current	for line clamp
		(mm ²)	(mm)	(mm)	G	(SW)	I _k 1 s (A)	
360 784 001	45°	95	20	38	M12	24	18700	360 330 002
360 385 001	90°	120	25	45	M12	27	23700	360 332 001 360 333 002
360 786 001	90°	70	20	75	M12	24	13800	360 330 002

Ball Pin, Angled, with Inside Thread



No.	Bracket	Max. cross section of connected cable (mm ²)	Head diameter (mm)	Thread G	Width across flats (SW)	Max. short-circuit current I _k 1 s (A)	for line clamp
360 385 002	45°	120	25	M12	27	23700	360 332 001 360 333 002
360 786 002	90°	70	20	M12	24	13800	360 330 002
611 370 001	45°	120	20	M12	24	23700	360 330 002

T-Bolts, Straight, with Outside Thread

suitable for universal line clamp P3.



No.	Max. cross section of connected cable (mm ²)	Diameter Ø (mm)	Width (mm)	Thread length (mm)	Thread G	Max. short-circuit current I _k 1 s (A)
360 372 001	95	15	30	28	M12	18700
360 372 002	95	15	30	48	M12	18700

T-Bolts, Straight, with Inside Thread

suitable for universal line clamp P3.



No.	Max. cross section of connected cable (mm ²)	Diameter Ø (mm)	Width (mm)	Thread G	Max. short-circuit current I _k 1 s (A)
610 670 001	95	20	58	M12	18700
615 805 001	95	15	30	M12	18700



T-Bolts, Angled, with Outside Thread

suitable for universal line clamp P3.

No.	Max. cross section of connected cable	Diameter	Width	Thread length	Thread	Max. short-circuit current
	(mm ²)	Ø (mm)	(mm)	(mm)	G	I _k 1 s (A)
360 567 001	95	15	30	28	M12	18700
360 567 002	95	15	30	48	M12	18700
600 925 001	95	15	30	38	M12	18700



T-Bolts, Straight, with Outside Thread

suitable for universal line clamp P5.

No.	Max. cross section of connected cable	Diameter	Width	Thread length	Thread	Max. short-circuit current	Max. torque
	(mm ²)	Ø (mm)	(mm)	(mm)	G	I _k 1 s (A)	(Nm)
360 386 001	120	20	58	28	M12	23700	56
360 386 002	120	20	58	48	M12	23700	56



Cylindrical Earthing Bolt with Outside Thread

To DIN 48088, part 2.

With annular groove.

Suitable for terminal sockets type A1 (No. 364 811 001) and A2 (No. 364 544 002).

No.	Thread	Thread length	Width across flats	Max. short-circuit current	Max. torque
	G	(mm)	(SW)	I _k 1 s (A)	(Nm)
360 407 407	M12	40	22	29600	56
360 408 408	M16	40	27	29600	135
360 408 003	M16	25	27	29600	135

Cylindrical Earthing Bolt with Inside Thread

To DIN 48088, part 2.

With annular groove.

Suitable for terminal sockets type A1 (No. 364 811 001) and A2 (No. 364 544 002).



No.	Thread	Width across flats	Max. short-circuit current	Max. torque
	G	(SW)	I_k 1 s (A)	(Nm)
610 923 001	M12	22	29600	56

Voltage Detecting Systems

Voltage detecting systems that meet Standard EN 61243-5:2001 are used for ensuring absence of voltage in metal-enclosed switchgear and transformers. As the live components in these systems cannot be contacted with voltage detectors, it is necessary to use voltage detecting systems that can clearly identify and indicate a capacitively coupled out signal as an operating voltage. This signal is coupled out by the integrated coupling electrodes that may be integrated in various components:

- Post-type insulator with capacitive voltage divider
- Transducer
- Bushings
- Duresca rails
- Outside/inside cone cable terminations

Voltage detection systems used for both medium and high voltages.

Standard EN 61243-5:2001 generally distinguishes between two systems, which define the interface conditions for the reliable operation of voltage detecting systems:

- HR systems (high resistance system)
- LRM systems (low resistance systems)

PFISTERER supplies the following components for both systems:

- Voltage detecting systems
- Connection materials such as connecting cables and connector strips
- Testing systems for testing voltage detecting systems
- Testing systems for testing interfaces
- Phase comparators

Our voltage detection systems are optimised for PFISTERER CONNEX connection technology components.

Indicators

These indicators show when operating voltage is present.

Continuous Voltage Indicator DSA-2

The **DSA-2 continuous voltage indicator** is a plug-in indicator for the HR system. It allows capacitively coupled out voltages to be checked for absence of voltage.

Technical description:

- No external power required
- Voltage indicator with flashing red LED
- All-insulated system (IP66) made of impact-resistant plastic with cast-on CEE plug connector
- Functioning test possible on the 230 V AC plug socket
- EURO-Test HR in-service test possible
- Suitable for all climatic zones



No.

827 161 005

Continuous Voltage Indicator DSA-LRM

The **DSA-LRM continuous voltage indicator** is a plug-in indicator for the LRM system. It allows capacitively coupled out voltages to be checked for absence of voltage.

Technical description:

- No external power required
- Voltage indication by flashing red LED
- All-insulated system (IP66) made of impact-resistant plastic
- Integrated connector pins with seal for interface
- In-service test possible with Euro-Test LRM
- Suitable for all climate zones



No.

827 020 001

VI

Indicators



Integrated Voltage Detecting System DSA-i3

The DSA-i3 integrated voltage detecting system has an integrated indicator. It is desired for use in switchgear. An additional display removes the need for in-service tests. This voltage detecting system is therefore particularly maintenance-free, reliable and cost-effective when used in continuous operation.

Technical description:

- No external power supply required
- Red LCD display
- Test sockets available for phase comparison
- Additional third socket for testing the integrated LCD display
- Secure cover for sockets
- Sensible test process using three feeler pins
- Integrated breaking point for voltage-limiting
- Simple assembly
- No in-service test required

No.	Nominal frequency f_N (Hz)	Threshold voltage (V)	Type of protection	Input impedance (M Ω)	Operation temperature (°C)	width x height x depth (mm)
827 216 003	50...60	4...5 V	IP 66	2	-25 ... +55	96 x 48 x 30

Additional Capacity for DSA-i3 Voltage Detecting System

Additional capacitances are available for adapting the DSA-i3 integrated voltage detection system to the interface; these can be plugged into the side of the voltage detection system.



No.	Version	Circuit board	Additional capacity (pF)
827 216 003	2	980 026 001	470 pF
827 216 003	3	980 026 002	2200 pF
827 216 003	4	980 026 003	3300 pF
827 216 003	5	980 026 004	10000 pF

Assembly Bracket

This practical assembly bracket is available for mounting the DSA-i3 integrated voltage detection system outside front panels.



No.
993 008 002

Interfaces and Connecting Leads

PFISTERER offers a range of interfaces and connecting leads for connecting indicators. Connecting leads on request.

Three-pole Interfaces for HR-System

This **three-pole interface for HR systems** is designed as a measuring and testing block with safety socket and earth socket. It can be mounted on switchgear.

Note:

To meet the standard, this interface must also be equipped with a rated breaking point for voltage limiting. The interface, the terminals on the coupling element, and the rated breaking point must be protected against humidity.



No.

560 915 001

Single-pole Interface for HR-System

This **single-pole interface for HR system** is designed as a test socket. It can be mounted anywhere near the capacitive tap.

Note:

The standard requires that this interface is also to be equipped with a rated breaking point for voltage limiting. The interface, the terminals on the coupling element, and the rated breaking point must be protected against humidity.



No.

827 668 001

Testers for Continuous Voltage Indicators

These testers can be used to carry out functioning tests on continuous voltage indicators. They can also be used for the in-service test. These testers are operated from a mains power outlet and, during the function test, simulate the minimum response threshold specified in the standard.

EURO-Test HR

The EURO-Test HR is suitable for checking the continuous voltage indicator of HR systems.



No.	Min. threshold voltage	Min. threshold current	Permissible ambient temperature	Standby indication
	U_{\min} (V)	I_{\min} (μ A)	($^{\circ}$ C)	
827 160 001	90	2.5	-25 ... +55	LED

EURO-Test LRM

The EURO-Test LRM is suitable for testing the continuous voltage indicator of LRM systems.



No.	Min. threshold voltage	Min. threshold current	Permissible ambient temperature	Standby indication
	U_{\min} (V)	I_{\min} (μ A)	($^{\circ}$ C)	
827 160 003	5	2.5	-25 ... +55	LED

Testers for Interfaces

These testers can be used for testing the interface.

MP-Test

This MP tester is suitable for testing the interfaces on HR systems and LRM systems. It can be used in connection with a multimeter.

No.

827 094 001



Testers for Continuous Voltage Indicators and Interfaces

PFISTERER offers testers for continuous voltage indicators and interfaces in one set.

Test Box

This test box contains testers for continuous voltage indicators and interfaces, and for the HR and LRM systems.

Technical description:

- Practical storage case with foam lining
- Multimeter
- MP test
- HR EURO test
- LRM EURO test

No.

827 092 002



Phase Comparators for Interfaces and Measuring Points

Phase comparators that meet standard EN 61243-5:2001 can be used to carry out phase comparisons on interfaces and measuring points.

Electronic Phase Comparators EPV

The **EPV universal phase comparator** allows phase comparison on interfaces and measuring points. It can be used for the HR system as well as the LRM system. It also allows checks for absence of voltage and tests on the interface.



Technical description:

- Integrated test leads
- Touchproof testing
- Function test and battery check with integrated self-test
- Integrated voltage indication
- Active phase balance indication by two LEDs (green=phase balance; red=phase unbalance)
- Interface control

No.	Scope of application	With 2 HR adapters	Nominal frequency	Weight	width x height x depth	Dimensions of carrying case (length/width/height)
			f_N (Hz)	(g)	(mm)	(mm)
827 189 007	LRM system	HR system	50...60	220	100 x 200 x 45	300 x 110 x 70

In-service Tests for Phase Comparators EPV

We provide in-service tests for the EPV phase comparator.

PFISTERER have been successfully carrying out these in-service tests on their own test equipment for many years. And this is how the EPV phase comparator is tested.

When the tests are completed, the results are documented in detail.

To request an In-service test, please contact your local sales agency.

For customers in Germany please use the following mailing address:

PFISTERER Kontaktsysteme GmbH & Co. KG
 Bereich Wiederholungsprüfung
 Bahnhofstraße 30
 89547 Gerstetten - Gussenstadt
 Germany



No.	Description
200 000 018	EPV

Adapter for Voltage Detectors

All KP-Test 5 Series single-pole voltage detectors are available either complete (with insulating poles) or separately (without insulating poles). With the separate type, the operator uses his own insulating poles. In this case, the minimum insulation requirements and minimum insulation lengths must be maintained.

PFISTERER offers a range of adapters for attaching separate KP-Test 5 voltage detectors to various connection variants.

Adapter, C1 Series

Adapter from PFISTERER hexagon to various other systems.

No.	Version	Description
935 100 001	C1A	Universal toothed coupling with groove
935 100 002	C1B	Spindle
935 100 003	C1C	Hexagon SW 12
935 100 004	C1D	„England“ version
935 100 005	C1E	Universal toothed coupling with M8 thread



Adapter, C2 Series

Adapter from universal adapter to various other systems. Can be used for KP-Test 5HL.

Adapters can be supplied on request.

No.	Version
935 101 002	C2B
935 101 003	C2C
935 101 004	C2D
935 101 005	C2F

Test Electrode Attachments for KP-Test 5



Angled Types, 90°

Can be used for all KP-Test 5 Series devices. For indoor installations only.

No.	Nominal voltage
	U_n (kV)
935 000 001	3 - 36



Types for Medium Voltage Overhead Lines

Can be used for all KP-Test 5 Series devices. For use on medium voltage overhead lines.

No.
935 000 002



Types for Special Switchgear, Type I

Can be used for all KP-Test 5 Series devices. For use on various Eaton, Holec and Magnefix switchgear. For indoor installations only.

No.	Nominal voltage
	U_n (kV)
935 000 003	3 - 15



Types for Special Switchgear, Type II

Can be used for all KP-Test 5 Series devices. For use on various Calor Emag, Isopond and Krone/KES switchgear with 11 mm diameter. For indoor installations only.

No.	Nominal voltage
	U_n (kV)
935 000 004	3 - 24



Types for Special Switchgear, Type III

Can be used for all KP-Test 5 Series devices. For use on medium voltage switchgear with 5.5 mm diameter. For indoor installations only.

No.	Nominal voltage
	U_n (kV)
935 000 005	1 - 10

Headpieces for Operating Poles

Switching Heads

all-insulated with actuating bolt

No.	Material
614 495 495	POM nf



Carrying case

Carrying Case for Voltage Detectors KP-Test 5

For safe transport and dust-free storage, PFISTERER supplies a high-quality carrying case for the KP-Test 5 voltage detector.

Technical description:

- Hard-shell case made of impact-resistant plastic
- Aluminium strips for edge protection
- Foam lining for KP-Test 5 voltage detector and related accessories



No.	Insertion depth of voltage detector	Width	Height	Depth
	A _i (mm)	(mm)	(mm)	(mm)
900 073 006	220	700	125	218
	393			
900 073 005	603	920	125	217

Carrying Case for Voltage Detectors KP-Test 5L

For safe transport and dust-free storage, PFISTERER supplies a handy carrying case for the KP-Test 5L voltage detector.

Technical description:

- Hard-shell case made of impact-resistant plastic
- Bright red colour with marking
- Foam lining for KP-Test 5L voltage detector and associated adapters



No.	Width	Height	Depth
	(mm)	(mm)	(mm)
900 075 001	444	320	108



Carrying Case for Single-pole Phase Comparators

Used for the safe transport and dust-free storage of phase comparators SPPC.

Technical description:

- Hard-shell case made of impact-resistant plastic
- Aluminium strips for edge protection
- Foam lining for phase comparator and accessories

No.	Width (mm)	Height (mm)	Depth (mm)	Suitable for
900 068 001	605	80	240	364788004
900 073 001	1020	80	250	364788002 364788003 364825002 364825003 364825004 364750001 364830001
900 073 002	900	190	250	364788001 364825001
900 073 003	888	143	235	364788001 364825001
900 073 004	1050	170	220	364788002 364788003 364825002 364825003

Carrying Case

Carrying Case for Voltage Detectors KP-Test 5

used for the safe transport and dust-free storage of KP-Test 5 voltage detectors.

Technical description:

- Storage case made of hard-wearing artificial leather
- Easy to close, using the Velcro fastener
- Flexibly adjustable carrying straps



No.	Insertion depth of voltage detector	Width (mm)	Height (mm)	Suitable for
	A ₁ (mm)			
364 887 002	220	730	260	930100003
	393			930100005
				930100010
				930110005
				930110010
				930110013
	930110020			
364 887 004	603	1000	260	930120003
				930120005
				930120010
364 887 003	910	1240	260	930140010
				930140020

Carrying Case for Single-pole Phase Comparators

used for the safe transport and dust-free storage of phase comparators SPPC.

Technical description:

- Storage case made of hard-wearing artificial leather
- Easy to close, using the Velcro fastener
- Flexibly adjustable carrying straps



No.	Width (mm)	Height (mm)	Suitable for
364 886 001	1050	410	364788001
			364788002
			364788003
			364825001
			364825002
			364825003
			364825004
364 887 001	700	260	364788004



Storage Cabinet for Voltage Detectors and Earthing Devices

This storage cabinet is designed to store voltage detectors, earthing devices and earthing rods. The storage cabinet protect against harmful environmental impact and abstraction by third parties.

Maximum storage compartment:

- 2 voltage detectors for overhead lines incl. carrying case
- 2 telescopic insulating poles
- 2 earthing devices

The storage cabinet is designed for fixing on walls or pylons.

Material:

- Sheet steel, galvanized and paint coated

No.	Dimensions (mm)	DB no.	DB drawing number
364 807 001	320 x 464 x 3000	00 777 517	3 Ebgw 04.42

Wall Holders

Flexible Wall Holders

Wall holder for space-saving storage and for holding KP-Test 5, one-pole phase comparators SPPC, operating and earthing poles.

Technical description:

- Holder made of impact-resistant plastic
- Clamping belt made of heavy-duty rubber
- Easily mounted on the guide bar provided, or directly on the wall



No.	for pole diameter (mm)
360 330 100	20 - 30
360 330 101	30 - 40

Guide Bars for Wall Holders

No.
360 330 102



Double Wall Holders

For storing earthing and short-circuiting devices at stations. Bracket with 2 fixing clamps for operating and/or earthing poles.

No.	Weight (kg)
360 877 001	0.8



Wall Holders for Earthing and Short-circuiting Devices

For storing earthing and short-circuiting devices at stations.

No.	Weight (kg)
360 878 001	5.2





Wall Holders for Fuses

For holding a set of HH fuses with fuse tongs For wall mounting, Ø 9 mm drill holes, hole spacing 390 mm.

No.	Weight (kg)
364 007 001	1.7



Retaining Clips for Operating and Earthing Poles

For wall mounting.

Technical description:

- For storing operating and earthing poles
- Spring bronze, electro- tinned
- Applicable for tube diameter 30 – 43mm
- With two mounting holes, each diameter: 5,5mm

No.	Material	Surface	Weight (kg)
360 323 323	Spring bronze	Electro-tinned	0.1

Other Accessories

Silicone Compound „DC 4“

For maintenance of all operating poles that meet DIN VDE 0681-1/10.86, following the related operating instructions.

No.	Type	Weight (g)
002 922 922	tube	100



Earthing Spikes

Technical description:

T-iron earthing spike, hot-dip galvanized, (without earthing cable), with M12 connecting screw and two half-shells for winding the extension earthing cable.

No.	Length (mm)	Weight (kg)
360 115 115	1300	3.7



Suspension Hook

For profile-free suspension of earthing wire.

No.	DB no.	DB drawing number
360 453 453	00157475	3 Ebgw 01.11



Spare Parts for Voltage Detectors KP-Test 5

Lithium Batteries

Can be used for all KP-Test 5 Series devices. Two batteries are required for each device.



No. _____

619 435 004

Sealing Rings for Indicator

Can be used for all KP-Test 5 Series devices.



No. _____

021 970 009

Threaded Rings for Indicator

Can be used for all KP-Test 5 Series devices.



No. _____

973 005 001

Forked Electrodes

Can be used for all KP-Test 5 Series devices from 1 to 36 kV nominal voltage with contact electrode extensions with M8 internal thread.



No. _____

973 210 001

Spare Parts for Earth Fittings

Connecting Clusters

Connecting cluster consisting of upper and lower parts, for use on multi-pole earthing and short-circuiting devices. Compression cable lugs and heat-shrink tubes are not included.

No.	Connecting cluster (mm ²)
622 680 004	25 - 35
622 685 005	50 - 70
622 681 006	95 - 150



Form for request for Earthing and Short-circuit devices

Company: _____ **Name:** _____

Telephone: _____ **Date:** _____

E-Mail: _____ **Signature:** _____

1 Type:

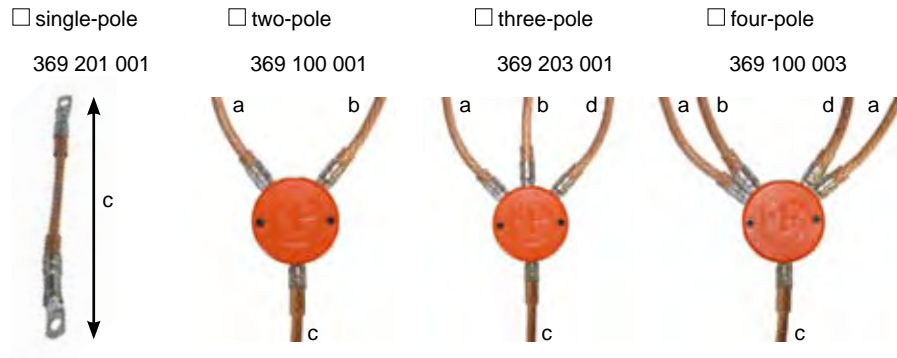

2 Cables:

Conductor cable cross-section: _____ mm²

Length of conductor cable: a: _____ mm b: _____ mm d: _____ mm

Earth cable cross-section: _____ mm²

Length of earth cable: c: _____ mm

3 Clamps

Line clamp: _____ Earth clamp: _____



Nr.	Seite	Nr.	Seite	Nr.	Seite	Nr.	Seite
0		360 528 531	56	364 084 087	43	364 844 001	61
002 922 922	97	360 567 001	80	364 084 089	43	364 845 001	59
021 970 009	98	360 567 002	80	364 112 003	44	364 845 002	59
2		360 628 002	62, 67	364 112 004	44	364 845 005	59
200 000 001	31	360 784 001	78	364 112 114	44	364 845 006	59
200 000 002	31	360 786 001	78	364 112 115	44	364 866 001	57
200 000 003	31	360 786 002	79	364 112 116	44	364 868 001	64, 70
200 000 004	31	360 786 003	78	364 115 001	43	364 886 001	93
200 000 005	31	360 877 001	95	364 116 000	45	364 887 001	93
200 000 006	31	360 878 001	95	364 153 153	42	364 887 002	93
200 000 012	35	360 938 095	77	364 153 154	42	364 887 003	93
200 000 014	31	360 938 939	77	364 153 155	42	364 887 004	93
200 000 016	35	361 346 001	62, 65	364 156 156	42	364 899 001	69
200 000 017	35	361 499	76	364 156 157	42	364 900 001	68
200 000 018	88	361 499 001	64	364 156 158	42	364 901 001	64, 70
200 000 200	31	361 499 499	64, 76	364 169 169	42	364 903 001	63, 71
3		361 657 001	62, 68	364 169 170	42	364 904 001	63, 71
360 115 115	97	361 657 002	62, 68	364 169 171	42	369 201 001	49, 50
360 323 323	96	361 658 001	62, 68	364 169 172	42	369 203 001	51 - 55
360 328 010	74	361 659 001	62, 68	364 169 173	42	5	
360 329 001	63, 73	362 000 001	39	364 169 174	42	560 915 001	85
360 330 002	63, 72	362 744	46	364 169 175	42	6	
360 330 100	95	362 744 744	46	364 169 597	42	600 925 001	80
360 330 101	95	362 745 002	46	364 212 001	43	610 670 001	79
360 330 102	95	362 745 745	46	364 309 005	63, 72	610 923 001	81
360 332 001	63, 72	362 808 808	37	364 454 004	23	611 370 001	79
360 333 002	63, 72	362 947 947	64, 76	364 456 002	22	612 633 004	78
360 335 003	63, 73	363 091 297	63, 74	364 456 003	23	612 633 005	78
360 335 004	63, 74	363 245 006	63, 73	364 456 005	22	614 495 495	91
360 372 001	79	363 280 002	41	364 459 009	63, 73	615 805 001	79
360 372 002	79	363 322 005	64, 70	364 544 002	62, 67	615 820 001	78
360 382 004	77	363 322 006	70	364 704 003	62, 66	615 822 001	78
360 382 005	77	363 418 003	64, 75	364 704 004	62, 66	619 435 004	98
360 382 006	77	363 463 463	68	364 714 002	62, 66	620 518 001	26
360 384 002	77	363 571 571	60	364 750 001	33	620 518 002	26
360 384 003	77	363 625 001	22	364 766 001	60	620 780 001	28
360 384 004	77	363 625 004	22	364 766 004	60	620 780 002	28
360 385 001	78	363 625 005	22	364 784 001	47	622 680 004	99
360 385 002	79	363 800 000	58	364 788 001	32	622 681 006	99
360 386 001	80	363 810 810	36	364 788 002	32	622 685 005	99
360 386 002	80	363 810 811	36	364 788 003	32	623 929 001	29
360 407 407	80	363 810 812	36	364 788 004	32	623 929 100	29
360 408 003	80	363 810 816	36	364 807 001	94	623 930 001	28
360 408 408	80	363 815 818	36	364 811 001	62, 66	624 333 502	25
360 414 001	62, 65	364 007 001	96	364 825 001	32	624 333 504	25
360 416 002	62, 67	364 035 004	38	364 825 002	32	624 334 501	25
360 419 004	62, 67	364 035 005	38	364 825 003	32	624 334 502	25
360 453 453	97	364 035 008	38	364 825 004	32	624 336 002	26
360 481 481	57	364 035 035	38	364 827 001	38	624 336 501	26
360 488 000	39	364 035 036	38	364 827 002	38	624 760 001	25
360 491 001	40	364 035 037	38	364 827 003	38	624 780 001	26
360 491 002	40	364 035 042	38	364 827 004	38	624 780 002	26
360 528 528	56	364 035 043	38	364 827 006	38		
360 528 529	56	364 084 001	43	364 827 007	38		
360 528 530	56	364 084 002	43	364 827 008	38		
		364 084 084	43	364 830 001	33		
		364 084 086	43	364 843 001	61		

Nr.	Seite	Nr.	Seite
8		973 005 001	98
827 020 001	83	973 210 001	98
827 092 002	87	973 500 001	25
827 094 001	87	973 501 001	25
827 160 001	86	993 008 002	84
827 160 003	86		
827 161 005	83		
827 189	88		
827 216 003	84		
827 668 001	85		
9			
900 068 001	92		
900 073 001	92		
900 073 002	92		
900 073 003	92		
900 073 004	92		
900 073 005	91		
900 073 006	91		
900 075 001	91		
930 100 003	11		
930 100 005	11		
930 100 010	11		
930 110 005	11		
930 110 010	11		
930 110 013	11		
930 110 020	11		
930 120 003	11		
930 120 005	11		
930 120 010	11		
930 140 010	11		
930 140 020	11		
930 190 001	20, 21		
930 190 501	12		
930 200 001	16		
930 200 002	16		
930 210 001	13		
930 210 501	14		
930 250 001	15, 19		
930 350 001	17		
930 350 501	18		
930 370 001	24		
930 450 001	34		
935 000 001	90		
935 000 002	90		
935 000 003	90		
935 000 004	90		
935 000 005	90		
935 100 001	89		
935 100 002	89		
935 100 003	89		
935 100 004	89		
935 100 005	89		
935 101 002	89		
935 101 003	89		
935 101 004	89		
935 101 005	89		